

# PRODISC® C VIVO

Cervical disc prosthesis to restore disc height and maintain segmental motion.



---

 Image intensifier control

**Warning**

This description alone does not provide sufficient background for direct use of Sentinel Spine products. Instruction by a surgeon experienced in handling these products is mandatory.

**Processing, Reprocessing, Care and Maintenance**

For general guidelines, function control and dismantling of multi-part instruments, as well as processing guidelines for implants, please contact your local sales representative or refer to:

[http://www.centinelspine.com/prodisc\\_reprocessing.html](http://www.centinelspine.com/prodisc_reprocessing.html)

For general information about reprocessing, care and maintenance of Sentinel Spine reusable devices, instrument trays and cases, please consult the Important Information leaflet (SE\_023827) or refer to:

[http://www.centinelspine.com/prodisc\\_reprocessing.html](http://www.centinelspine.com/prodisc_reprocessing.html)

# TABLE OF CONTENTS

---

INTRODUCTION	<b>prodisc C Vivo</b>	2
	Kinematics	3
	Intended Use, Indications and Contraindications	4
<hr/>		
SURGICAL TECHNIQUE	Surgical Technique	5
	Multi-Level Cases	14
	Removal Procedure	15
<hr/>		
PRODUCT INFORMATION	Implants	17
	Instruments	19
	Pre-Cleaning Instructions	26
<hr/>		
BIBLIOGRAPHY		28

## FEATURES AND BENEFITS

---

prodisc C Vivo is intended to replace a diseased and/or degenerated intervertebral disc of the cervical spine in patients with symptomatic cervical disc disease. The prodisc C Vivo procedure

is intended to significantly reduce pain by allowing for the removal of the diseased disc while restoring disc height and providing the potential for motion at the affected vertebral segment.

### **Simple surgical technique**

- Simple technique with two main steps: trial and implant insertion

### **Anatomical design**

- Convex superior plate for anatomical fixation
- Trapezoidal footprint design for optimal anatomical fit and maximum endplate coverage

### **Proven materials**

- Superior and inferior implant plates made from titanium alloy for improved MRI compatibility.
- Rough surface coating of pure titanium allows bony ongrowth
- Inlay made from ultra-high molecular weight polyethylene (UHMWPE)
- UHMWPE on CoCrMo alloy articulation

### **Ball and socket articulation**

- Permits a physiological range of motion in flexion/extension, rotation, and lateral bending
- Allows for restoration of anatomical balance
- Resists shear forces



# KINEMATICS

prodisc C Vivo has a center of rotation which is located just below the inferior endplate of the prosthesis. Pure translation movements are controlled by the ball and socket inter-face.

## Flexion/extension

The location of the center of rotation (COR) and the flexion radius are in accordance to the natural joint guidance in the vertebral joints.

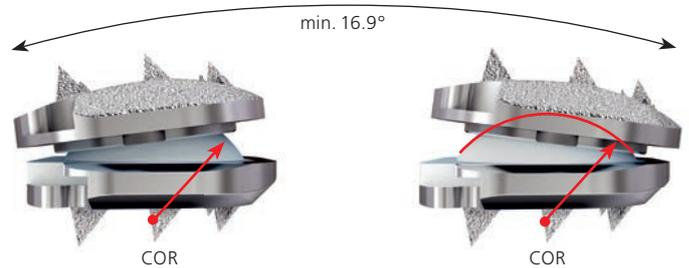

## Lateral bending

The physiological range of motion in lateral bending is restored.

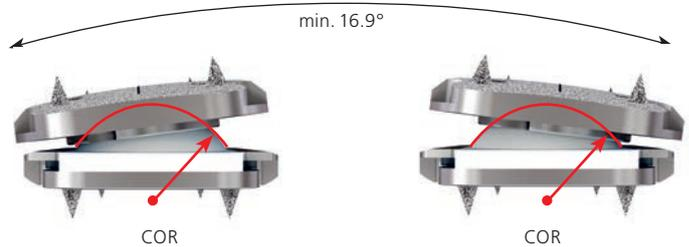

## Axial rotation

The axial rotation is limited by the anatomical structures and not by the prosthesis.



# INTENDED USE, INDICATIONS AND CONTRAINDICATIONS

---

## Intended use

prodisc C Vivo implants are used to replace a cervical intervertebral disc, to restore disc height and maintain segmental motion.

Successful clinical outcomes depend on a number of critical factors, including:

- Completion of a training program on the use of prodisc C, prodisc C Nova or prodisc C Vivo
- Proper patient selection
- Adequate bone quality (investigation to determine bone quality is recommended)
- Complete and meticulous discectomy, decompression, and remobilization of the disc space
- Optimal implant sizing and placement
- Postoperative treatment

## Indications

Symptomatic cervical disc disease (SCDD), which is defined as neck or arm (radicular) pain and/or a functional/neurological deficit with at least one of the following conditions confirmed by imaging (CT, MRI, or x-rays):

- herniated nucleus pulposus
- spondylosis (defined by the presence of osteophytes)
- loss of disc height

## Specific contraindications

- Fractures, infections, tumors
- Spinal stenosis by hypertrophic spondylarthrosis
- Severe facet joint degeneration
- Segmental instability
- Ossification of posterior longitudinal ligament (OPLL)

## General contraindications

- Osteoporosis, osteochondrosis, and severe osteopenia
- Acute or chronic systemic, spinal, or localized infections
- Systemic and metabolic diseases
- Any medical and surgical conditions precluding the benefits of spinal surgery
- Foreign body sensitivity to the implant materials
- Pregnancy
- Severe obesity (Body Mass Index above 40)

## Patient exclusion recommendations

Patient selection is one of the most important factors contributing to the outcome of the total disc replacement procedure. The following may affect clinical outcomes:

- A condition of senility or mental illness, alcoholism or smoking
- Dependency on pharmaceutical drugs or drug abuse
- The patient's occupation or activity level
- Compromised vertebral bodies at affected level due to current or past trauma (fractures)
- Substantial loss of disc height, where applied segmental distraction may lead to damage of the great vessels
- Involved vertebral endplate dimensionally smaller than the minimum implant footprint size in both the medial-lateral and the anteriorposterior directions
- Severe abnormality of the endplate (e.g. large Schmorl nodes)

# SURGICAL TECHNIQUE

## 1

### Prerequisites and patient positioning

Insertion of a **prodisc C Vivo** is dependent on the use of anterior-posterior (AP) and lateral fluoroscopy throughout the procedure. Patient positioning should allow for circumferential use of the C-arm at the operative level.

Position the patient in a supine, neutral position on a radiolucent operating table. Ensure that the neck of the patient is in a sagittally neutral position and supported by a cushion. When treating C6–C7 make sure that the shoulders do not limit the x-ray monitoring. In any case both vertebrae should be completely visible.



## 2

### Access

Use a standard anterior approach to the cervical spine. Mark the level of the surgery and expose the intervertebral disc segment and adjacent vertebrae.

- ① Determine the median line using image intensifier control and make a permanent midline mark on the superior and inferior vertebral bodies, e.g. using an osteotome or electro cauterization.

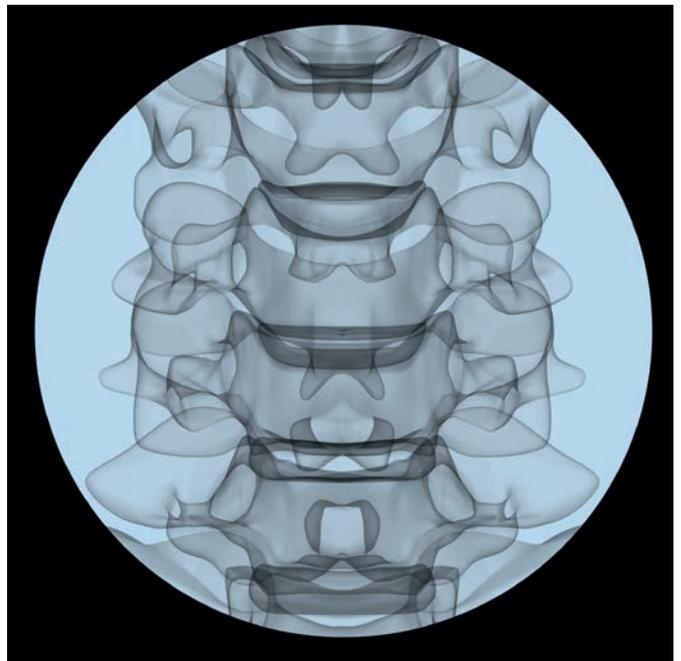

### 3

#### Fix retainer screw system

##### Instruments

03.820.100	Punch
03.820.101	Screwdriver
03.820.111	Vertebral Body Retainer
03.820.102– 03.820.109	Retainer Screws
03.820.110	Locking Nut

Perforate the anterior cortex of the superior and inferior vertebra in the lateral midline and vertical center with the punch.

Insert retainer screws into the perforations and place them close to the posterior cortical wall. Their trajectory should be parallel to the endplates of the treated disc. Begin with the smaller diameter screws (3.5 mm) of the longest possible length. Use a larger diameter screw (4.5 mm) when extra bone purchase is needed or a smaller screw diameter has been used unsuccessfully (“rescue” screw).

##### Warning:

- **Insert screws under image intensifier control for optimal trajectory and depth control.**
- **Do not perforate the posterior cortex with the tip of the screw.**

Slide the vertebral body retainer over the screws and lock it in place with the locking nuts. This assembly secures parallelism of the retainer screws and the vertebral endplates of the operated level.

Avoid using the retainer to distract the segment. For proper distraction refer to Step 4 on page 7.

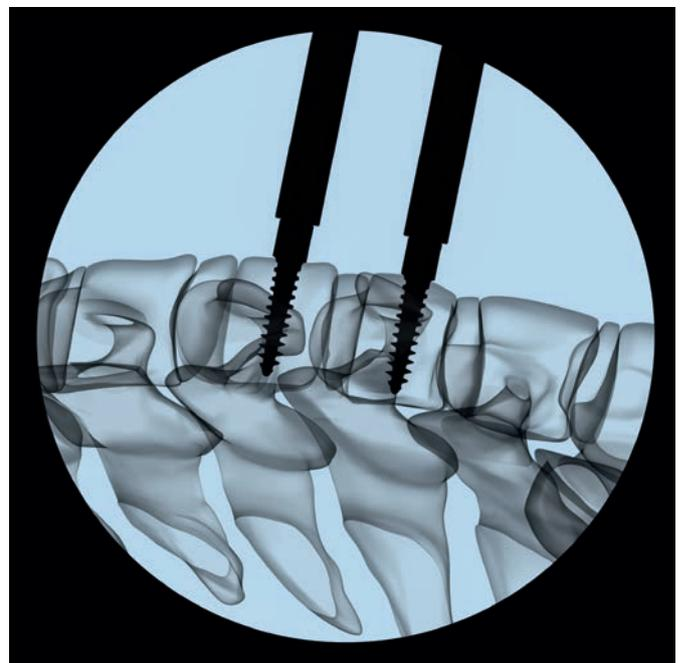
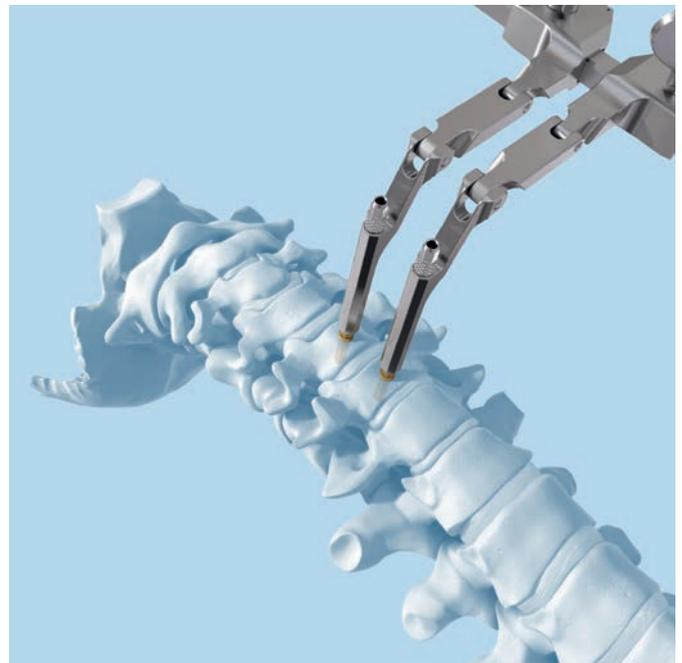

---

## 4

### Mobilize and distract the segment

---

#### Instrument

---

03.820.112      Vertebral Distractor

---

Start the discectomy using standard instruments.

Remove as much disc material as possible to allow the vertebral distractor tips to be placed as posteriorly as possible into the intervertebral space. Mild predistraction with the retainer can be applied to support disc removal.

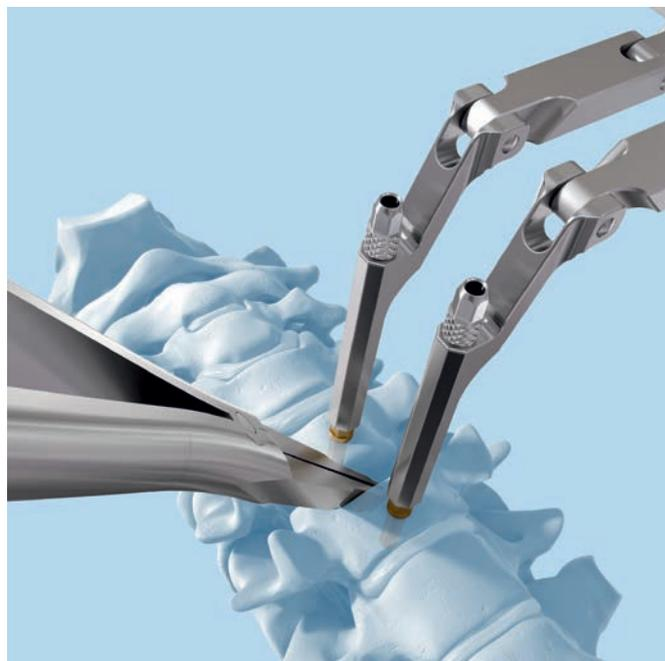

- 1 Under fluoroscopic control, insert the tip of the vertebral distractor to the posterior margin of the vertebral bodies. Distract the intervertebral space with the vertebral distractor to restore the height and to gain access to the posterior intervertebral space. Readjust the retainer to the distracted height of the intervertebral space. This step should be repeated until maximum distraction has been achieved. Then release and withdraw the vertebral distractor.

Continue the discectomy and remove the cartilageous endplate carefully. All soft tissue must be removed from the endplates. Care should be taken to avoid damage of the endplates.

Continue with the canal and foraminal decompression.

**Precaution:**

- **Avoid using the vertebral body retainer as a distractor. Excess force on the vertebral body retainer can lead to bending and/or pull-out of the screws from the bone.**
- **Expose the posterior longitudinal ligament to remobilize the segment. If required for decompression, the PLL may be resected.**

**Warning:**

- **Avoid overdistract with the vertebral distractor as this can lead to nerve root tension or improper implant selection.**
- **Avoid excessive endplate damage or removal. This increases the risk of implant subsidence.**
- **The uncinata process should be preserved. If required for adequate decompression, the posterior third of the uncinatus process may be removed.**
- **Ensure the cartilageous tissue is removed from the endplates. Cartilageous tissue may hinder osseointegration of the implant and reduce the fixation strength.**

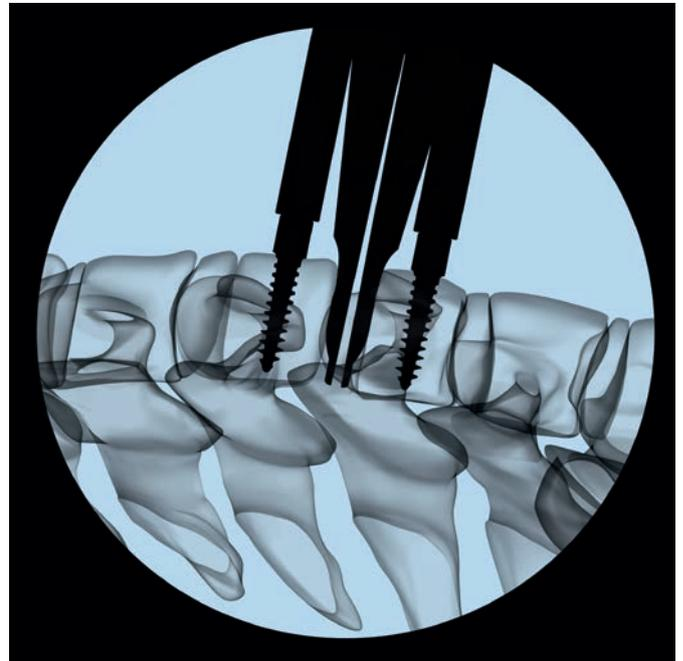

---

## 5

### Define the implant size

---

#### Instruments

---

03.670.925– 03.670.977	Trial Implants
03.670.204	Holder for Trial Implants
03.820.113	Mallet

---

After completing discectomy and decompression, use the trial implants to determine the appropriate disc height and size of footprint.

**The goal is to select a prosthesis with the best possible anatomical fit, using the largest footprint and the smallest height needed to restore the natural disc.**

Prosthesis center of rotation (COR) should be positioned at the midline of the vertebral body or slightly posterior. The implant should cover the majority of the vertebral body end-plate. Implants with undersized footprints lead to increased risk of implant subsidence and heterotopic ossification.

Insert the inner shaft of the holder for trial implants into the corresponding sleeve and push it until it snaps into place. Select the appropriate trial implant and make sure that its protrusion is captured in the stop of the shaft before assembling. Ensure that the shaft is fully screwed in before use.

- Align the trial implant with the midline and advance it under image intensifier control into the disc space by tapping it cautiously.

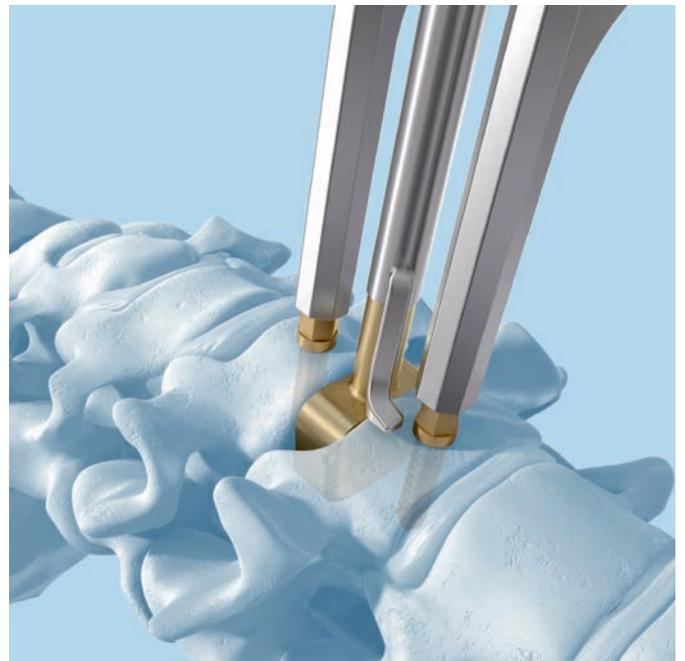

- ① In the **lateral fluoroscopy view** the optimal position of the trial implant is given by the best possible anatomical fit. If the stop does not allow the trial implant to go deep enough, the stop can be adjusted by turning the trial shaft counter clockwise (1 rev = 0.5 mm), enabling the trial implant to be advanced slightly deeper. At the same time the trial implant should be kept centered on the midline.

Now release the distraction to determine if the trial implant height is appropriate for the patient. Its height should be the smallest height to match normal adjacent discs. When the correct size for the implant is determined, the trial implant is removed (apply slight distraction with the vertebral retainer if necessary).

**Precaution:**

- **Selecting an implant that is too tall can limit the segmental range of motion.**
- **Avoid kyphotic position of the corresponding segment.**

**Note:**

- **Do not unscrew stop more than 4mm or contact to trial implant may be lost. Use next size trial implant instead.**

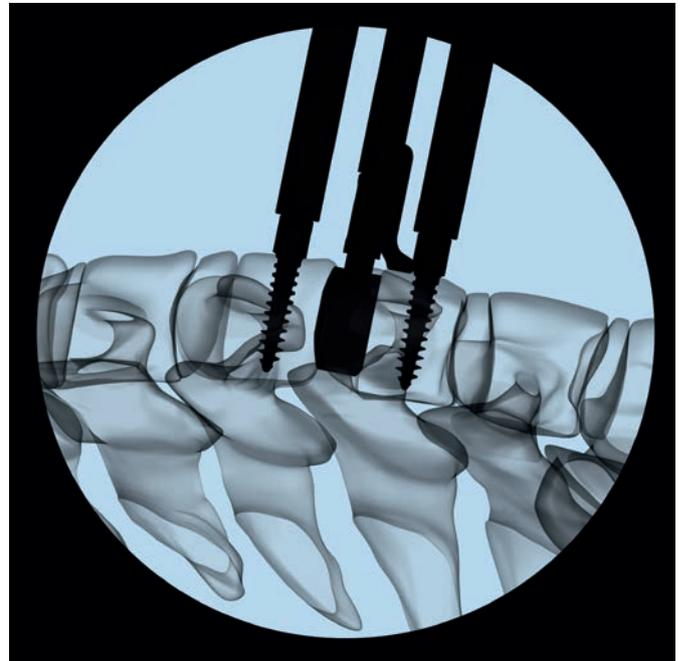

## 6

### Insert implant

#### Instruments

03.670.201– 03.670.203	Implant Holder
03.670.213	Shaft for Implant Holder
03.670.212	Stop for Implant Holder (optional)
03.670.305– 03.670.307	Spacer Clamp, sizes M/MD, heights 5–7 mm
03.670.315– 03.670.317	Spacer Clamp, sizes L/LD, heights 5–7 mm
03.670.325– 03.670.327	Spacer Clamp, sizes XL/XLD, heights 5–7 mm
03.820.113	Mallet
03.820.101	Screwdriver
03.670.207	Positioner

#### Preparation

Assemble the shaft for the implant holder. Open the packaging of the implant and follow these steps:

- Choose spacer clamp size M/MD, L/LD or XL/XLD corresponding to the implant.
- Attach the appropriate spacer clamp to the prosthesis until the arms snap into the holding features in the implant.
- Attach the corresponding implant holder (M/MD, L/LD or XL/XLD) to the spacer clamp, making sure that the lateral projections of the spacer clamp are captured in the arms of the implant holder.
- Tighten the implant holder to the spacer clamp turning the head of the inner shaft clockwise.
- Pull the implant en-bloc out of the packaging tray.

Optionally, the stop can be attached to the implant holder.

**Note:** The **prodisc C Vivo** implants are not designed to be used with bone cement.



### Insertion

Apply distraction as necessary, to facilitate the insertion of the implant.

Ensure that the black midline on the superior endplate faces cranially and align it with the midline marking of the vertebral body.



Without Stop



With Stop

- Under lateral fluoroscopic control, advance the implant into its final position providing the best possible anatomical fit with the vertebral bodies. The center of rotation (COR) of the prosthesis should be positioned at the midline of the vertebral body or slightly posterior. Avoid excessive cranial, caudal or lateral corrections during insertion and ensure that the implant doesn't exceed the posterior margin of the vertebral body.

- The spacer clamp includes two grooves that visualize the anterior margin of the implant under lateral fluoroscopy.

If the correct position of the implant is confirmed using image intensifier, release the retainer and apply slight compression with the retainer. Slight compression from the retainer will help the spikes on the implant to penetrate into the vertebral bodies.

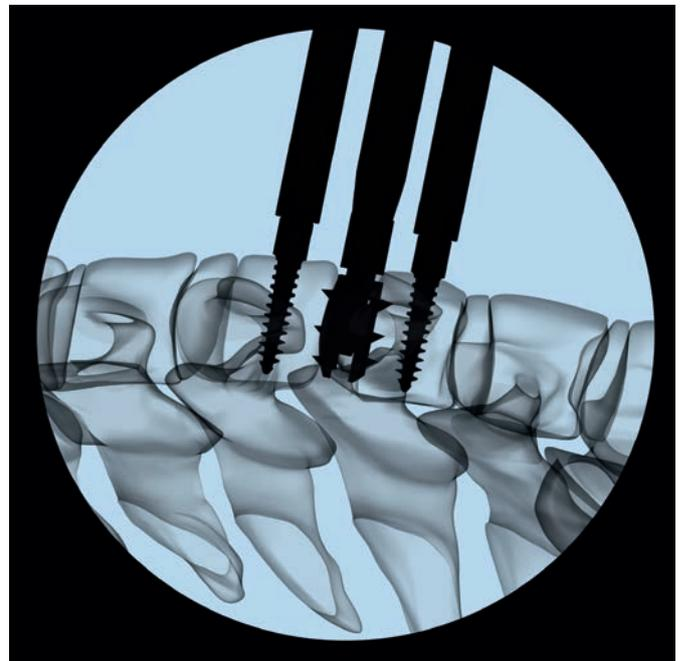

---

**Release**

To release the connection between spacer clamp and implant, follow the two steps below:

1. Rotate the shaft of the implant holder two full turns in the counterclockwise direction.
2. Move the implant holder sideward and pull it back until the spacer clamp disconnects from the implant.

Step by step remove the locking nuts, the vertebral body retainer and the retainer screws.

**Precaution:** Heterotopic ossification (HO) is a possible cause for fusion of the treated segment. Copious saline lavage is recommended to remove osteogenic stimuli (blood/bone marrow). HO might be reduced when bone wax is used to close cavities in the bone (screw holes) and open bone surfaces after removal of anterior osteophytes.<sup>1</sup>



<sup>1</sup> See Barbagallo 2014

# MULTI-LEVEL CASES

The most symptomatic level should be operated first.

Multi-level **prodisc C Vivo** surgeries should be performed sequentially level by level.

If no symptomatic difference between the levels can be identified, start operating the most collapsed or caudal one.

The retainer screws should be placed centrally in the vertebrae according to the surgical technique for single levels.

- ① Insert the screws under image intensifier control.
- ① Repeated image intensifier control in AP direction will be necessary to ensure proper alignment of the disc prostheses.

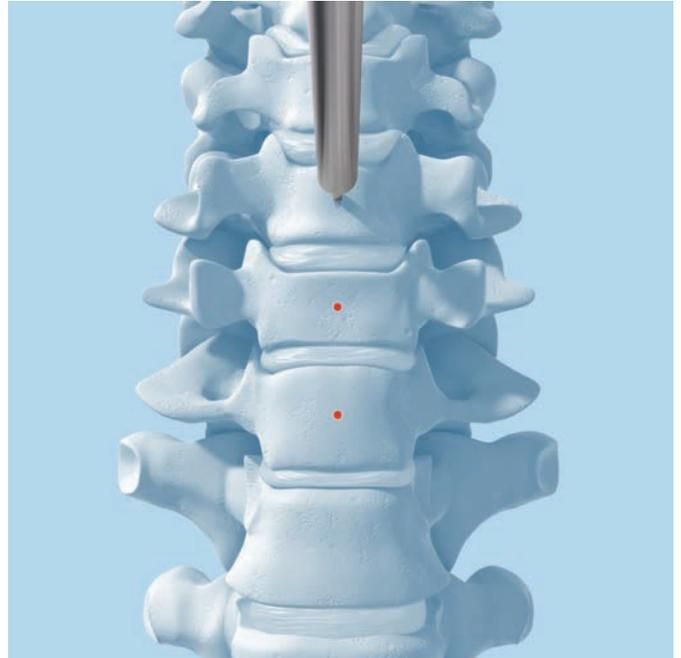

# REMOVAL PROCEDURE

If a prodisc C Vivo implant must be removed, the following technique is recommended.

## 1

### Preparation

#### Instruments

03.670.201– 03.670.203	Implant Holder
03.670.213	Shaft for Implant Holder
03.670.400	Remover Clamp size M/MD
03.670.410	Remover Clamp size L/LD
03.670.420	Remover Clamp size XL/XLD

Start the procedure by distracting the prosthesis index level by using the vertebral distractor and the retainer system. See page 6 for details on how to use the retainer system.

Attach the appropriate remover clamp to the corresponding implant holder with minimal thread engagement without tightening the head of the inner shaft of the implant holder.

**Note:** If the thread of the shaft is fully engaged and tightened, the remover clamp cannot be attached to the implant in the next step.

Attach the remover clamp assembly to the inferior endplate of the implant and securely attach it by turning the head of the implant holder shaft in clockwise direction.

**Note:** The surface edged with “inside” must be oriented towards the center of the disc space with respect to the implant endplate being removed.

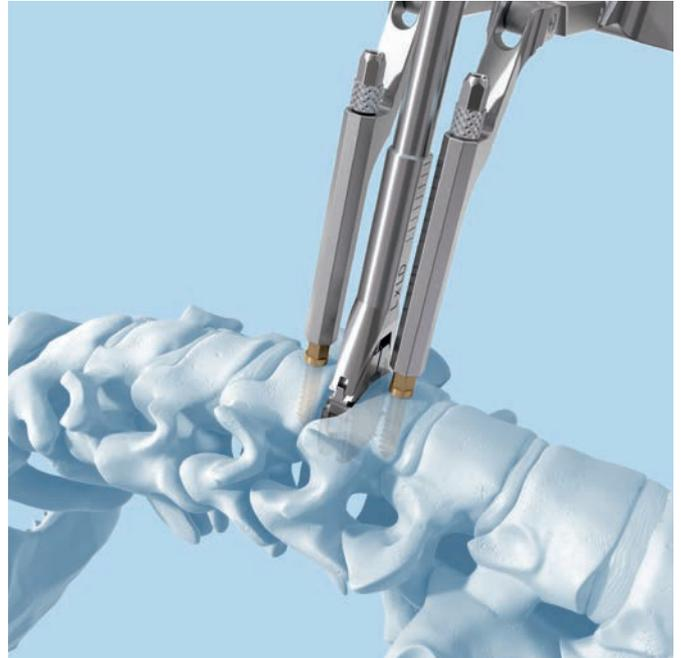

## 2 Implant Removal

### Instruments

03.670.201– 03.670.203	Implant Holder
03.670.213	Shaft for Implant Holder
03.670.400	Remover Clamp size M/MD
03.670.410	Remover Clamp size L/LD
03.670.420	Remover Clamp size XL/XLD
03.820.113	Mallet
03.820.282	Slide Hammer

Remove the inferior endplate of the implant by cautiously pulling the implant holder. Alternatively, the slotted mallet or slide hammer can be used to aid implant removal.

The superior endplate of the implant can be removed using the remover clamps or alternatively suitable forceps.

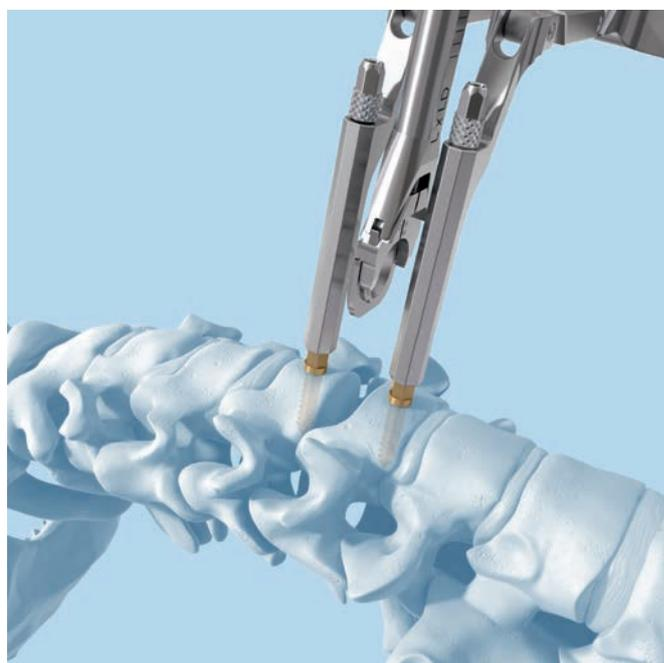
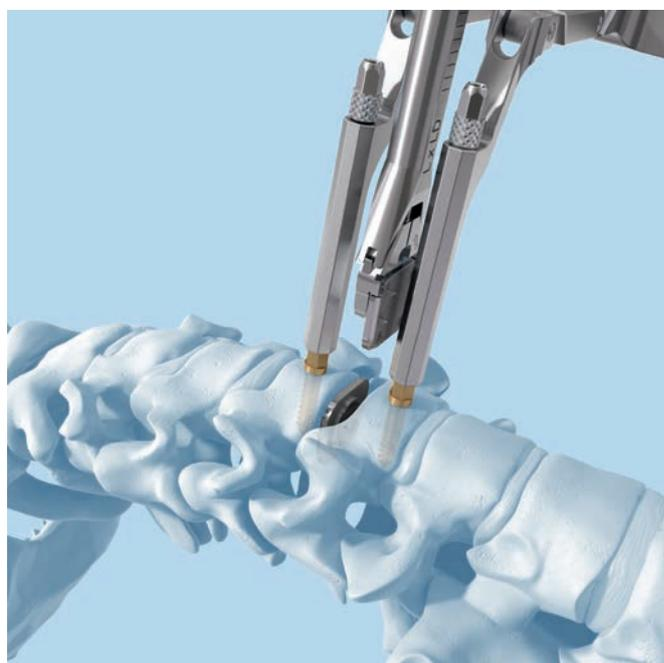

# IMPLANTS

## Dimensions

Six different footprints are available for optimal coverage of the vertebral endplate: M, MD, L, LD, XL, XLD.

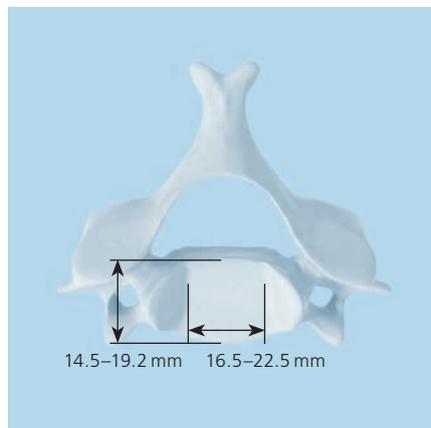

Panjabi 1991

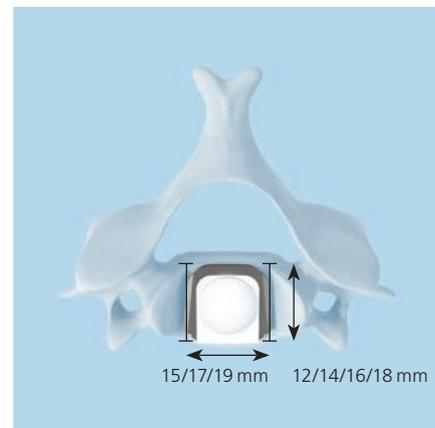

Three different heights (5, 6, and 7 mm) allow adjustment to the individual dimensions of the patient's disc.

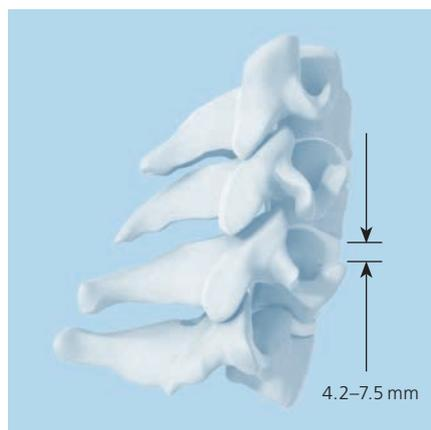

Yoganandan et al. 2001

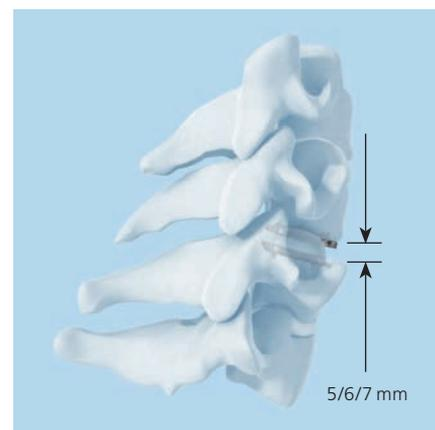

**The prodisc C Vivo implant** consists of two titanium endplates. The superior endplate has a convex shape, while the inferior plate is flat. There are six spikes on both plates.

prodisc C Vivo has always been based on the ball and socket principle with a “poly-on-metal” pairing. The polyethylene inlay (ball) is securely locked in the lower endplate while the upper endplate embraces the calotte (socket) made of CoCrMo alloy.



**prodisc C Vivo, uncemented**

**Implant M**

Width 15 mm  
Depth 12 mm

Art. No.	Height
04.670.925S	5 mm
04.670.926S	6 mm
04.670.927S	7 mm

**Implant MD**

Width 15 mm  
Depth 14 mm

Art. No.	Height
04.670.935S	5 mm
04.670.936S	6 mm
04.670.937S	7 mm

**Implant L**

Width 17 mm  
Depth 14 mm

Art. No.	Height
04.670.945S	5 mm
04.670.946S	6 mm
04.670.947S	7 mm

**Implant LD**

Width 17 mm  
Depth 16 mm

Art. No.	Height
04.670.955S	5 mm
04.670.956S	6 mm
04.670.957S	7 mm

**Implant XL**

Width 19 mm  
Depth 16 mm

Art. No.	Height
04.670.965S	5 mm
04.670.966S	6 mm
04.670.967S	7 mm

**Implant XLD**

Width 19 mm  
Depth 18 mm

Art. No.	Height
04.670.975S	5 mm
04.670.976S	6 mm
04.670.977S	7 mm

# INSTRUMENTS

---

The **prodisc C Vivo** instrument set was developed for a minimally invasive or microscopic procedure.

## Retainer screw system

---

03.820.100 Punch



---

03.820.101 Screwdriver



---

03.820.111 Vertebral Body Retainer

The vertebral body retainer is used to maintain the distraction achieved with the vertebral distractor.

The retainer has a toggle-switch mechanism to maintain distraction as well as compression.



**Retainer Screw Ø  
3.5 mm**

Art. No.	Length of thread
03.820.102	12 mm
03.820.103	14 mm
03.820.104	16 mm
03.820.105	18 mm

**Retainer Screw Ø  
4.5 mm**

Art. No.	Length of thread
03.820.106	13 mm
03.820.107	15 mm
03.820.108	17 mm
03.820.109	19 mm



03.820.110 Locking Nut



03.820.112 Vertebral Distractor



## Trial Implants

Trial implants are used to define the correct size of the implants (height, width and depth).



**Trial Implant M**

Width 15 mm  
Depth 12 mm

Art. No.	Height
03.670.925	5 mm
03.670.926	6 mm
03.670.927	7 mm

**Trial Implant MD**

Width 15 mm  
Depth 14 mm

Art. No.	Height
03.670.935	5 mm
03.670.936	6 mm
03.670.937	7 mm



**Trial Implant L**

Width 17 mm  
Depth 14 mm

Art. No.	Height
03.670.945	5 mm
03.670.946	6 mm
03.670.947	7 mm

**Trial Implant LD**

Width 17 mm  
Depth 16 mm

Art. No.	Height
03.670.955	5 mm
03.670.956	6 mm
03.670.957	7 mm



**Trial Implant XL**

Width 19 mm  
Depth 16 mm

Art. No.	Height
03.670.965	5 mm
03.670.966	6 mm
03.670.967	7 mm

**Trial Implant XLD**

Width 19 mm  
Depth 18 mm

Art. No.	Height
03.670.975	5 mm
03.670.976	6 mm
03.670.977	7 mm



03.670.204 Holder for Trial Implants



**Insertion instruments**

The preassembled and sterile packed prodisc C Vivo prosthesis can be easily secured on the implant holder. The spacer clamp can be easily attached onto the preassembled and sterile packed prodisc C Vivo prosthesis.

**Spacer Clamp M/MD**

Art. No.	Height
03.670.305	5 mm
03.670.306	6 mm
03.670.307	7 mm



**Spacer Clamp L/LD**

Art. No.	Height
03.670.315	5 mm
03.670.316	6 mm
03.670.317	7 mm



**Spacer Clamp XL/XLD**

Art. No.	Height
03.670.325	5 mm
03.670.326	6 mm
03.670.327	7 mm



03.670.201	Implant Holder, size M and MD
03.670.202	Implant Holder, size L and LD
03.670.203	Implant Holder, size XL and XLD



---

03.670.212 Stop for Implant Holder



---

03.670.213 Shaft for Implant Holder



---

03.820.113 Mallet



---

03.820.282 Slide Hammer for Cervical Spine



---

03.670.207 Positioner



---

03.670.400 Remover Clamp, size M/MD



---

03.670.410 Remover Clamp, size L/LD



---

03.670.420 Remover Clamp, size XL/XLD



# PRE-CLEANING INSTRUCTIONS

Please note that the manual pre-cleaning method has to be performed for instruments and cases prior to automated cleaning.

Please consider the following positions for the pre-cleaning process:

Position 1

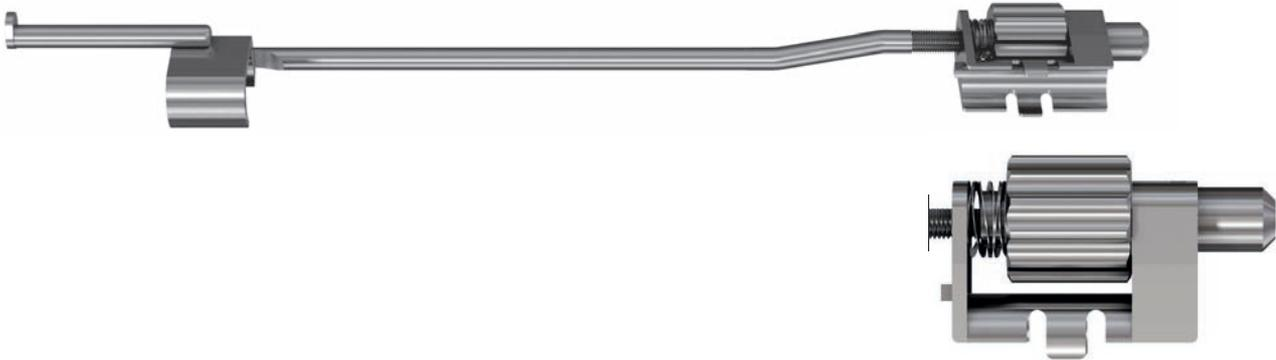

Position 2

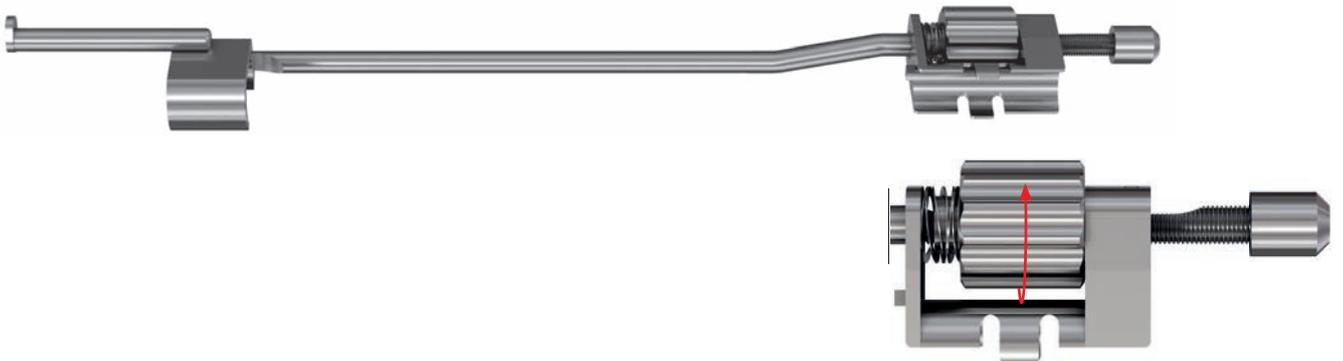

Actuate in Position 2

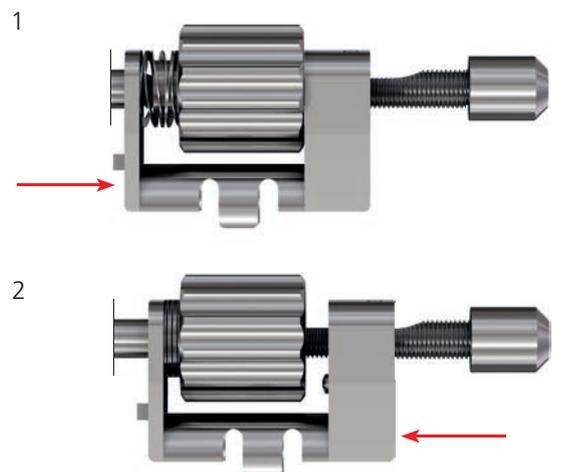

---

**1. Perform the following cleaning steps with the stop for implant holder in position 1:**

Step Duration (minimum) Cleaning instructions

- 1) (1 minute) Rinse soiled device under running cold tap water. Remove gross soil using a soft-bristled brush or soft, lint-free cloth.
- 2) (2 minutes) Manually clean device in a newly-made enzymatic cleaner or detergent solution. Use a soft-bristled brush to remove soil and debris. Actuate joints, handles and other movable device features to expose areas to detergent solution several times. Clean device under water to prevent aerosolization of contaminants.
- 3) (1 minute) Rinse device using cool to lukewarm running tap water. Use a syringe, pipette or water pistol to flush lumens and channels. Actuate joints, handles, and other movable device features in order to rinse thoroughly under running water.

**2. Change the stop for implant holder to position 2 and repeat the 3 steps above, while actuating in position 2:**

- 1) Leave the stop for implant holder at position 2 and perform the last step below:
- 2) (15 minutes) Clean device ultrasonically at 40 °C. Prepare a newly-made detergent solution using an enzymatic cleaner or detergent.

For general guidelines, function control and dismantling of multi-part instruments, please contact your local sales representative or refer to:

Reprocessing, Care and Maintenance of Centinel Spine Instruments  
[www.centinelspine.com/prodisc\\_reprocessing.html](http://www.centinelspine.com/prodisc_reprocessing.html)

# BIBLIOGRAPHY

- Barbagallo G.M.V., Certo F, Visocchi M, Sciacca G, Albanese V (2014) Double-level cervical total disc replacement for adjacent segment disease: is it a useful treatment? Description of late onset heterotopic ossification and review of the literature. *Eur Rev Med Pharmacol Sci* 18 (1): 15–23
- Bertagnoli R, Duggal N, Pickett GE, Wigfield CC, Gill SS, Karg A, Voigt S. (2005) Cervical total disc replacement, part two: clinical results. *Orthop Clin North Am* 36(3): 355–62.
- Bertagnoli R, Yue JJ, Pfeiffer F, Fenk-Mayer A, Lawrence JP, Kershaw T, Nanieva R. (2005) Early results after ProDisc-C cervical disc replacement. *J Neurosurg Spine* 2(4): 403–10.
- Delamarter R, Murrey D, Janssen M, Goldstein J, Zigler J, Tay B, Darden B. Results at 24 months from the prospective, randomized, multicenter Investigational Device Exemption trial of Prodisc-C versus anterior cervical discectomy and fusion with 4-year follow-up and continued access patients. *SAS Journal* 2010 (4): 122.128.
- DiAngelo DJ, Foley KT, Morrow BR, Schwab JS, Song J, German JW, Blair E. (2004) In vitro biomechanics of cervical disc arthroplasty with the ProDisc-C total disc implant. *Neurosurg Focus* 17 (3): E7.
- Durbhakula MM, Ghiselli G (2005) Cervical total disc replacement, part I: rationale, biomechanics, and implant types. *Orthop Clin North Am* 36(3): 349–54. Review.
- Korinth MC (2008) Treatment of cervical degenerative disc disease – current status and trends. *Zentralbl Neurochir.* 69(3): 113–24
- Kuchta J, Simons P (2007) Zervikale Bandscheibenprothese – Eine bewegungserhaltende Therapieoption. *Orthopädie & Rheuma* 1(2008): S32–S36
- Mehren C, Suchomel P, Grochulla F, Barsa P, Sourkova P, Hradil J, Korge A, Mayer HM. (2006) Heterotopic ossification in total cervical artificial disc replacement. *Spine* 31(24): 2802–6.
- Murrey D, Janssen M, Delamarter R, Goldstein J, Zigler J, Tay B, Darden B (2008) Results of the prospective, randomized, controlled multicenter FDA investigational device exemption study of the ProDisc-C total disc replacement versus anterior discectomy and fusion for the treatment of 1-level symptomatic cervical disc disease. *Spine J.* 2009 Apr; 9(4): 275–86. Epub 2008 Sep 6.
- Nabhan A, Ahlhelm F, Shariat K, Pitzen T, Steimer O, Steudel WI, Pape D. (2007) The ProDisc-C prosthesis: clinical and radiological experience 1 year after surgery. *Spine* 32(18): 1935–41.
- Rabin D, Bertagnoli R, Wharton N, Pickett GE, Duggal N. (2008) Sagittal balance influences range of motion: an in vivo study with the ProDisc-C. *Spine J.* 2009 Feb; 9(2): 128–33. Epub 2008 Jul 10.
- Rousseau MA, Cottin P, Levante S, Nogier A, Lazennec JY, Skalli W. (2008) In vivo kinematics of two types of ball-and-socket cervical disc replacements in the sagittal plane: cranial versus caudal geometric center. *Spine* 33(1): E6–9





© 2018 Centinel Spine, LLC or its affiliates. All rights reserved.

**Prodisc is distributed by:**

**CENTINEL SPINE, LLC**

900 Airport Road, Suite 3B  
West Chester, PA 19380  
Tel: 484.887.8810  
Fax: 800.493.0966  
cs@centinelspine.com  
www.centinelspine.com

Centinel Spine® is a registered trademark of  
Centinel Spine, LLC.

This publication is not intended for distribution in  
the USA. Not all products are currently available  
in all markets.

**Prodisc is manufactured by:**

Synthes GmbH  
Eimattstrasse 3  
CH-4436 Oberdorf  
Switzerland

Prodisc® is a registered trademark of  
DePuy Synthes.

LBL409 Rev 1 (01/2018)

**CE**  
0123