



Surgical Technique Guide

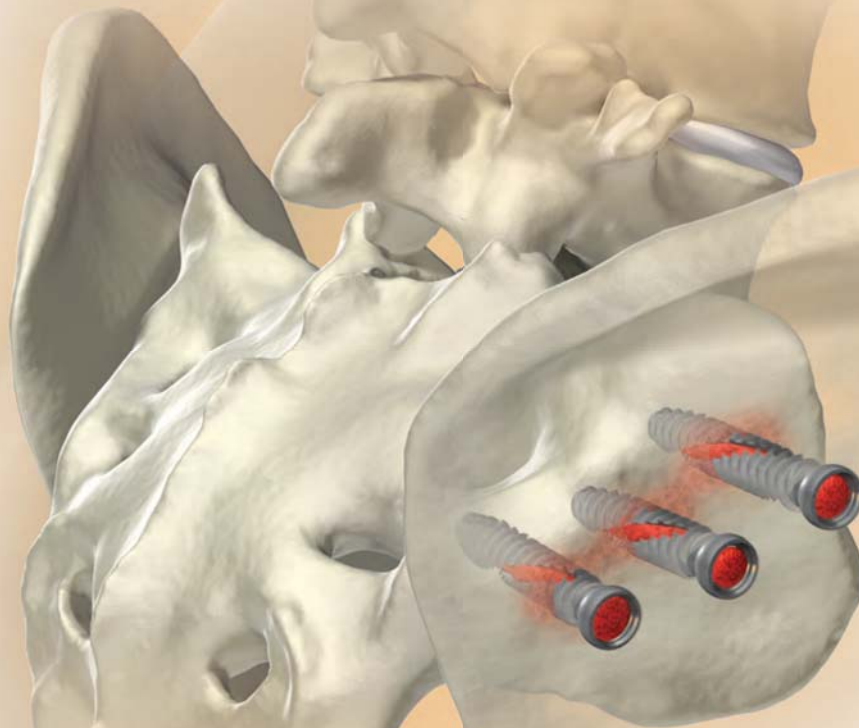

Table of Contents

SiCure® Implant Overview 2

SiCure® System Information 3

X-ray Basics 4

Patient Positioning 5

Surgical Technique 6

Implant Removal Instructions 17

Instrument / Implant Guide 18



SiCure® Implant Overview

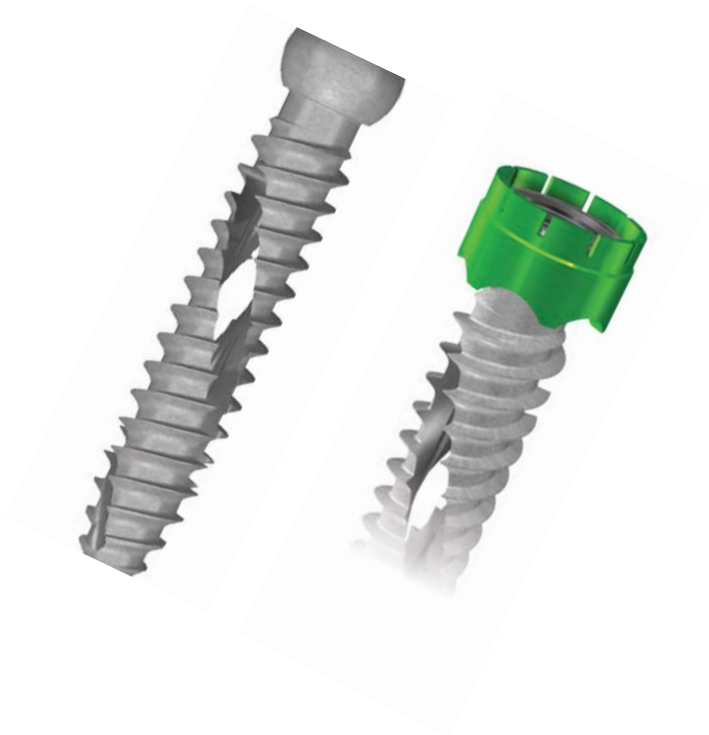

- ✓ 9.5mm Diameter
- ✓ Optional Load Distribution Cap
- ✓ Self-Harvesting
- ✓ Lengths 35-60mm
- ✓ Self-Advancing

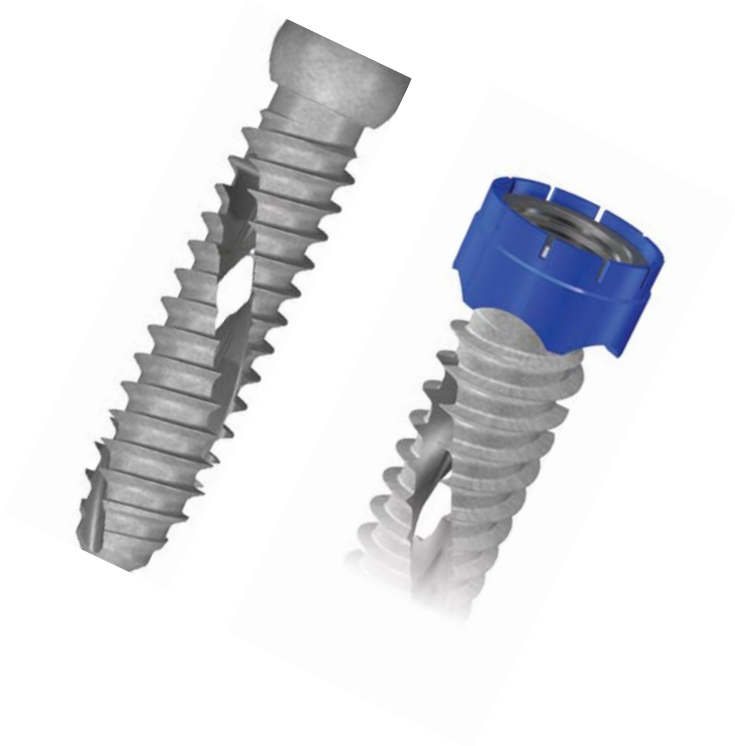

- ✓ 11mm Diameter
- ✓ Optional Load Distribution Cap
- ✓ Self-Harvesting
- ✓ Lengths 35-60mm
- ✓ Self-Advancing



Product Description

The SiCure Sacroiliac Joint Fusion System consists of cannulated, fully threaded screws with double helix threads designed to be able to screw into pre-drilled bone. It is fabricated from medical grade titanium alloy, Ti-6Al-4V (ASTM F-136). The SiCure System screw comes in various sizes and lengths to accommodate patient anatomy. Optional pivoting washers are included for each screw diameter to aid in conforming to patient anatomy.

Surgical Instrument System





The SiCure Sacroiliac Joint Fusion System is comprised of various surgical instruments to be used to prepare the site to insert the system implants. All the instruments are made from surgical grade materials.

Indications for Use





The SiCure Sacroiliac Joint Fusion System is intended for large bone fixation, including sacroiliac joint fusion for conditions including sacroiliac joint disruptions and degenerative sacroiliitis.

Contraindications

Contraindications for use of the SiCure Sacroiliac Joint Fusion System includes, but is not limited to:

-  Infection
-  Tumor
-  Severe osteoporosis
-  Mental or physical impairments that limit a patient's ability to comply with necessary limitation of postoperative instructions

Refer to the SiCure Sacroiliac Joint Fusion System package insert document (FRM-002.4) for:

-  Warnings and Precautions
-  Potential Adverse Events
-  Cleaning & Sterilization
-  Packaging & Storage

X-ray Basics

INLET VIEW

Fluoroscopy is positioned 25-35 degrees Caudal.
This trajectory allows the Pelvic Brim to be viewed.

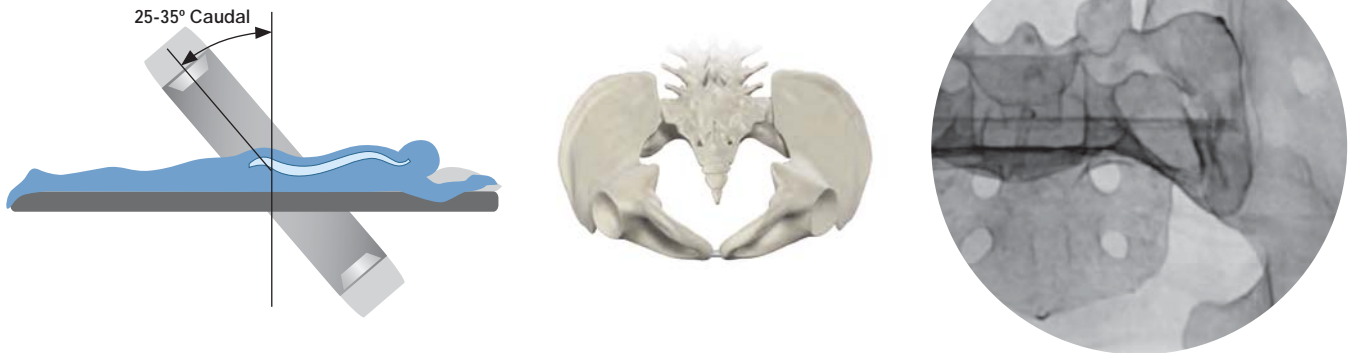

OUTLET VIEW

Fluoroscopy is positioned 25-35 degrees Cephalad.
This trajectory allows the Sacral Foramen to be viewed in an open position.

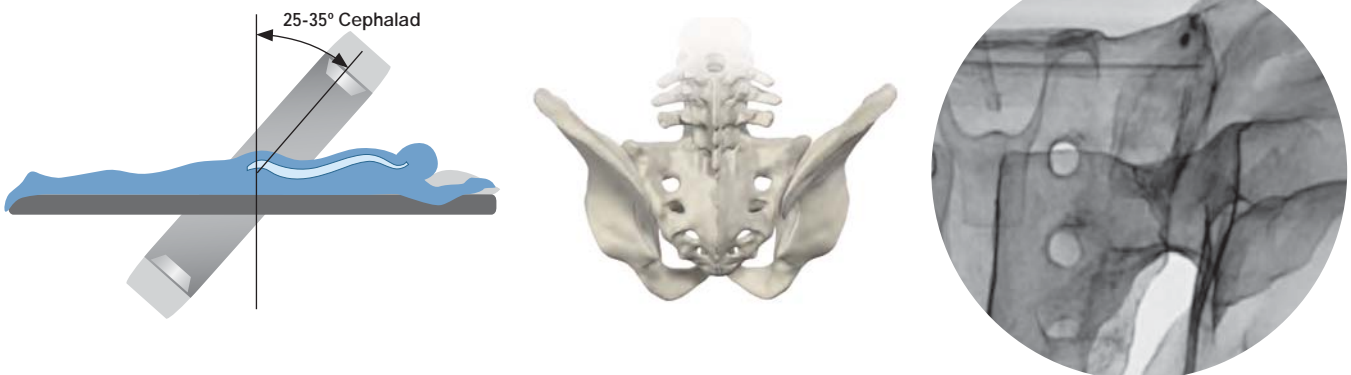

LATERAL VIEW

Fluoroscopy is positioned directly at the Sacrum.
This trajectory allows the Alar Lines, Posterior/Anterior Sacral Walls and the S1 endplate to be viewed.



Patient Positioning

It is recommended to place the patient in the prone position on a radiolucent table, similar to a Jackson, and drape according to surgeon preference.

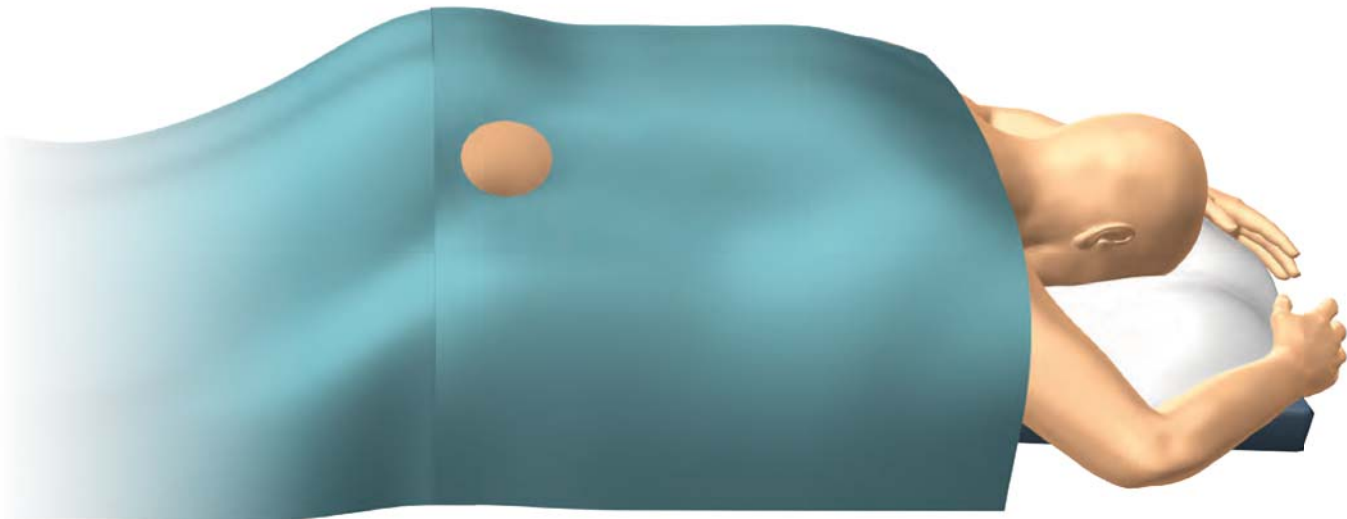

Note: Once patient positioning has been completed, make sure the C-arm can move freely to acquire the inlet, outlet, and lateral views.

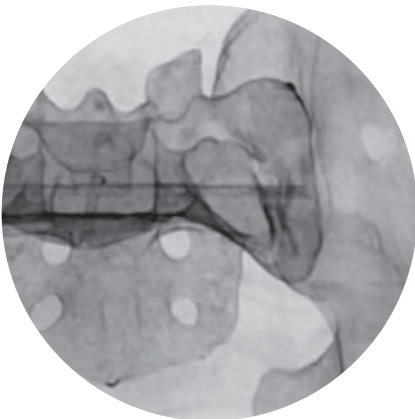

Inlet

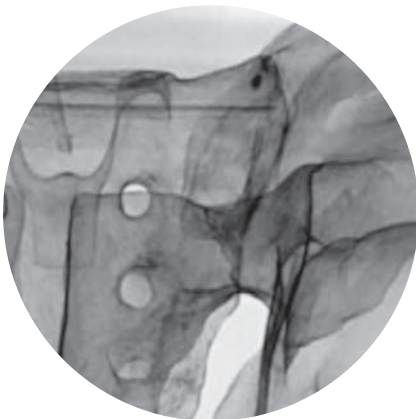

Outlet

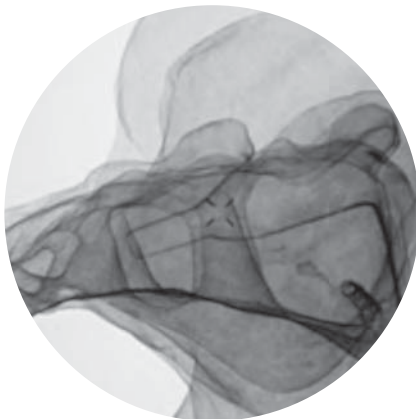

Lateral

Surgical Technique

1 Targeting Instructions

Position the C-arm in a lateral view and identify both Alar lines.

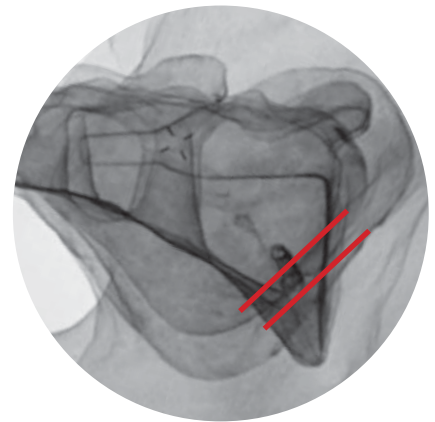
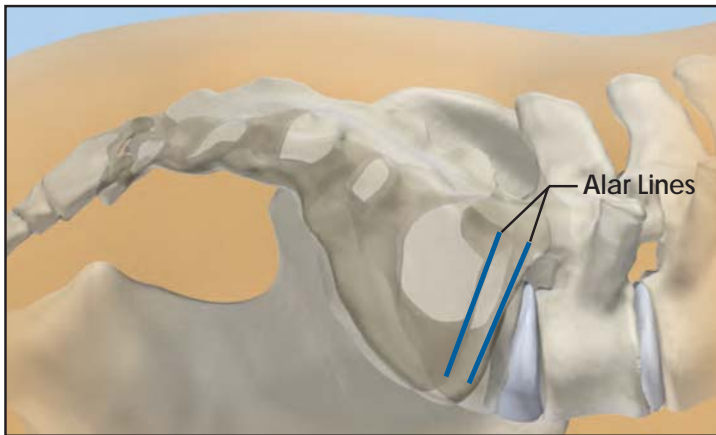

2 Instruct the C-arm technician to "wag" the C-arm to achieve a superimposed image of the Alar lines to define a "true lateral" view.

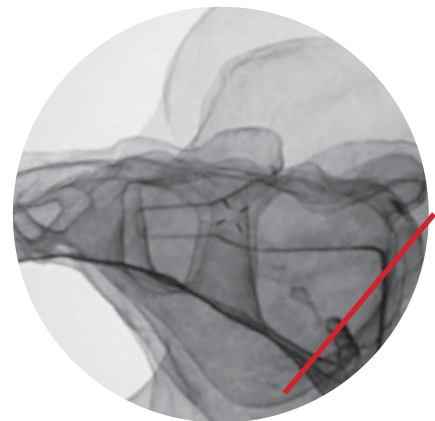
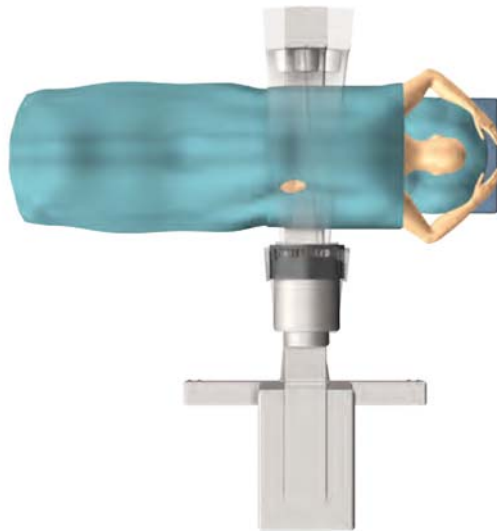

3 Once fluoroscopy is positioned in a "true lateral" view, mark along the Alar line with a skin marker.

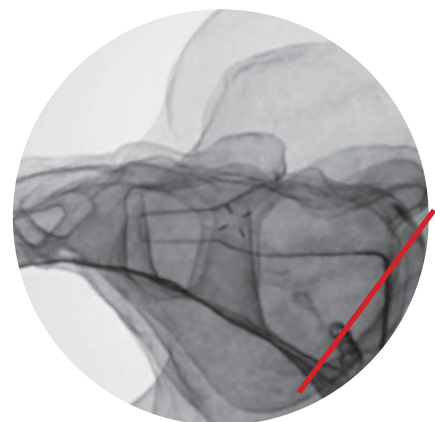
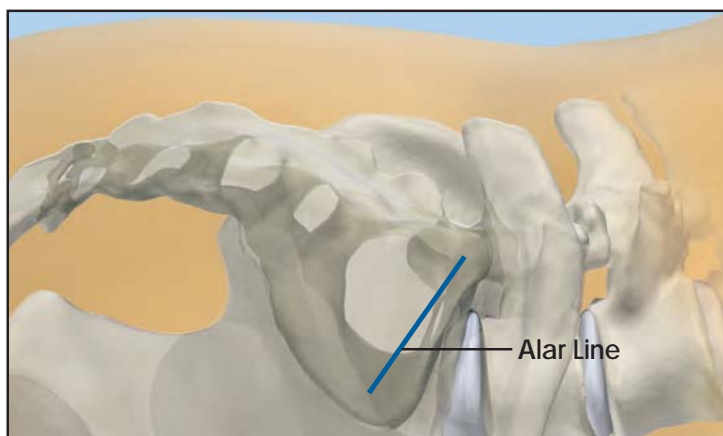

Surgical Technique (cont.)

- 4 Using the same “true lateral” view, locate the Posterior Sacral Wall. Mark along the Posterior Sacral Wall until it connects with the previously marked Alar line, step 3.

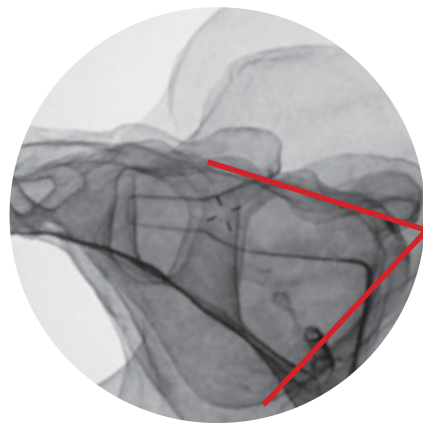
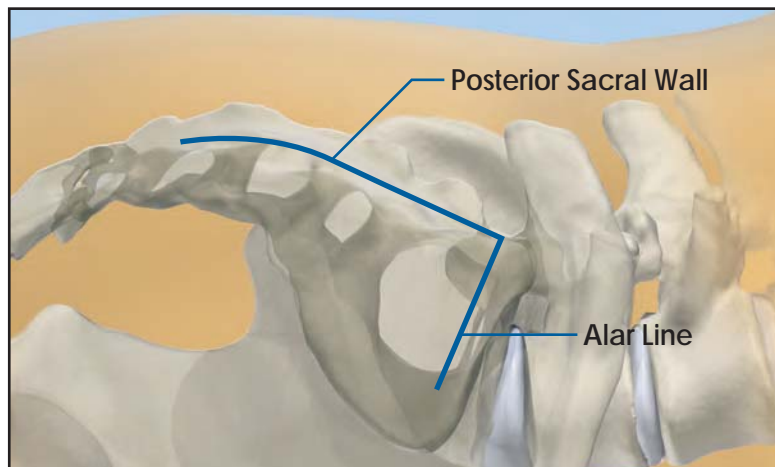

- 5 Make a 2 to 3cm incision approximately 2cm anterior to the Posterior Sacral Wall, and approximately 1cm inferior to the Alar line.

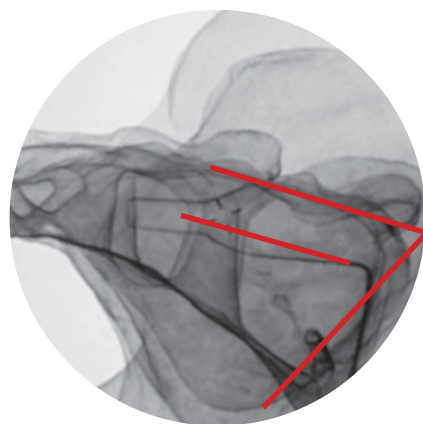
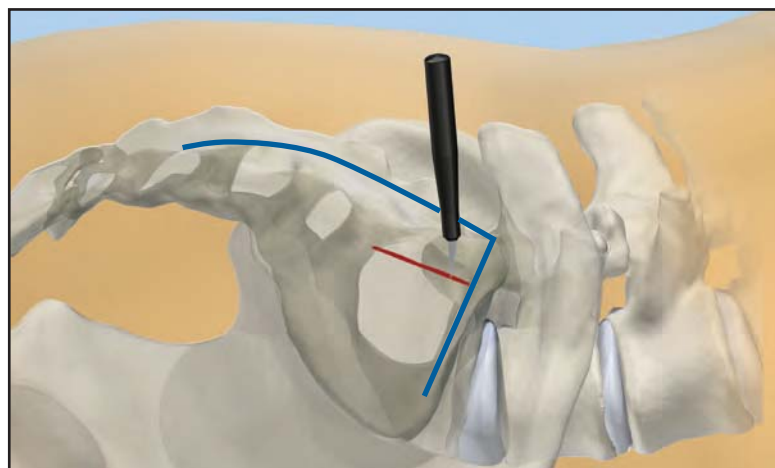

Surgical Technique (cont.)

6 Steinmann Pin Placement

Position the first Steinmann Pin approximately 2cm anterior of the Posterior Sacral Wall and 1cm inferior to the Alar line.

Note: Keeping the Steinmann Pin parallel to the floor helps prevent misplacement and/or breaches.

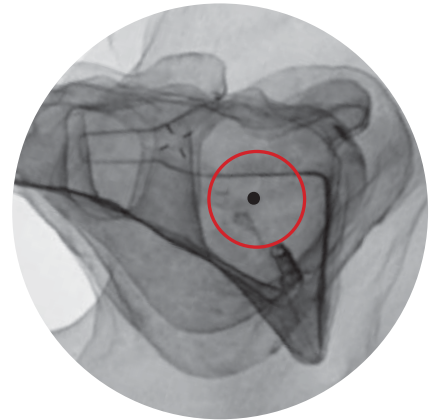
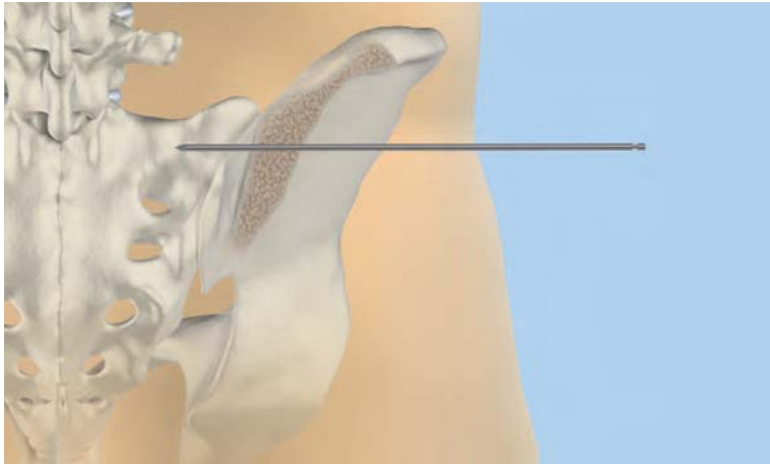

7 Once the placement of the first Steinmann Pin has been confirmed in the lateral view, advance the Steinmann Pin with the mallet into the Ilium approximately 2mm.

Confirm placement of the Steinmann Pin in the Outlet and Inlet views before advancing across the joint and into the Sacrum.

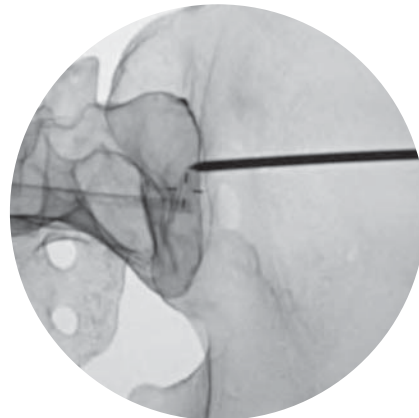
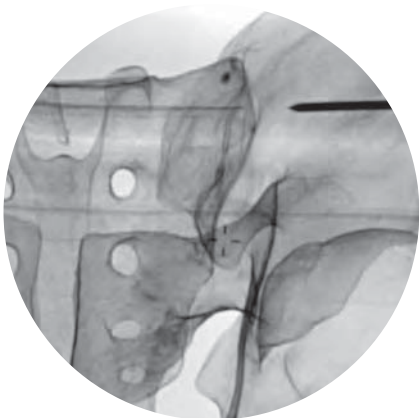

8 Once placement of the Steinmann Pin has been achieved, advance the Steinmann Pin with the mallet to the desired depth.

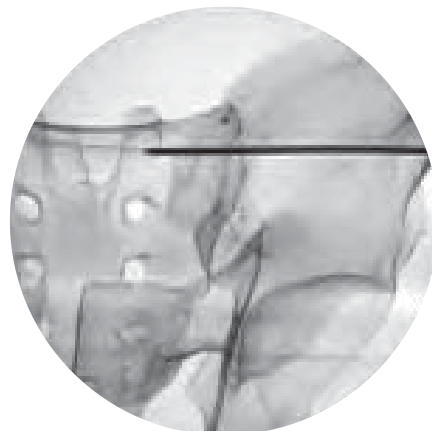

Surgical Technique (cont.)

9 Dilation

Select the #1 Dilator and position over the Steinmann Pin. Advance the #1 Dilator until secure on the wall of the Ilium.

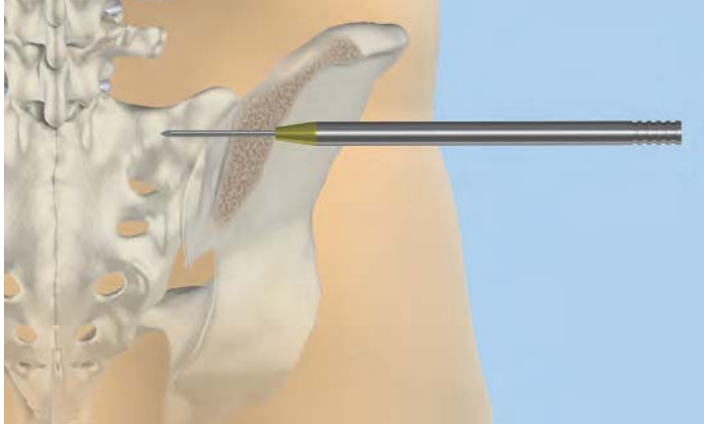

10

Select the #2 Dilator and position over the #1 Dilator and advance until secure on the wall of the Ilium.

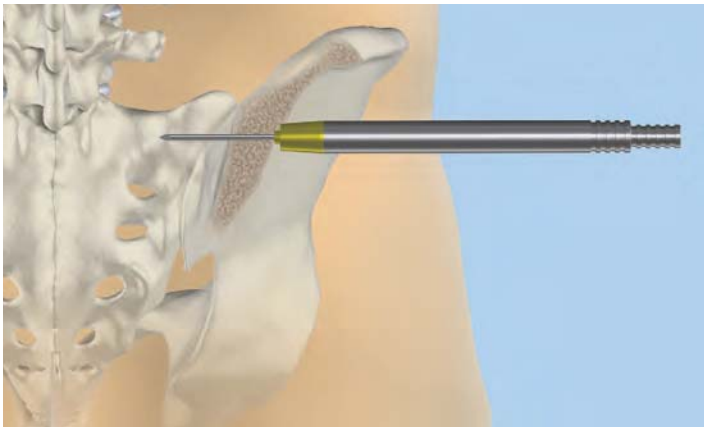

11

Select the #3 Dilator and position over the #2 Dilator and advance until secure on the wall of the Ilium. Remove both inner dilators, #1 and #2.

Optionally, attach the Dilator Guide Handle to the #3 Dilator for additional stability.

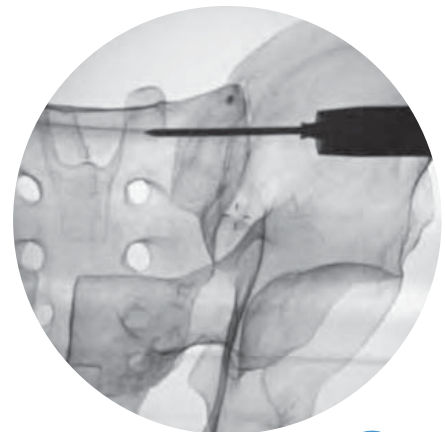
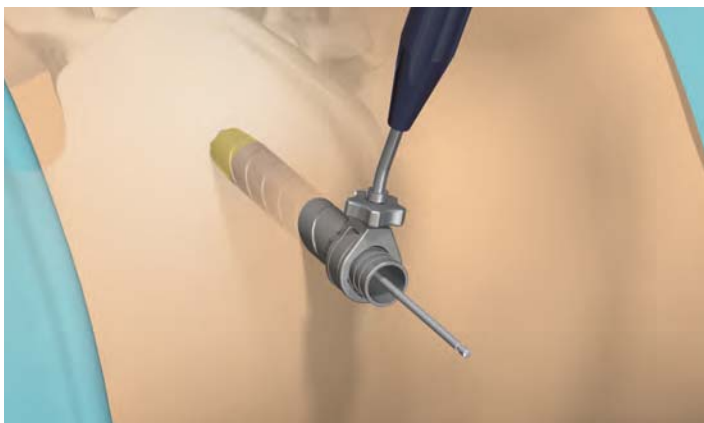

Surgical Technique (cont.)

12 Implant Sizing/Drilling

Select the Steinmann Pin Depth Gauge and place over the Steinmann Pin and inside the #3 Dilator. Advance the Depth Gauge until secure on the wall of the Ilium to determine the length of the implant.

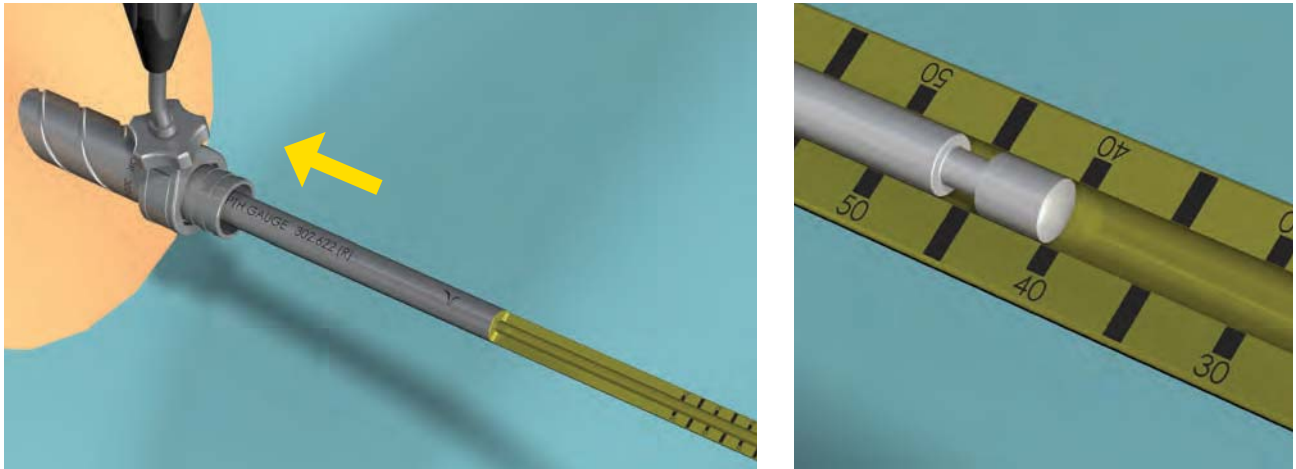

13 Select desired implant diameter: 9.5mm or 11mm. Attach the appropriate Drill Bit to the desired power unit.

Note: Power unit must utilize a Jacobs adaptor.

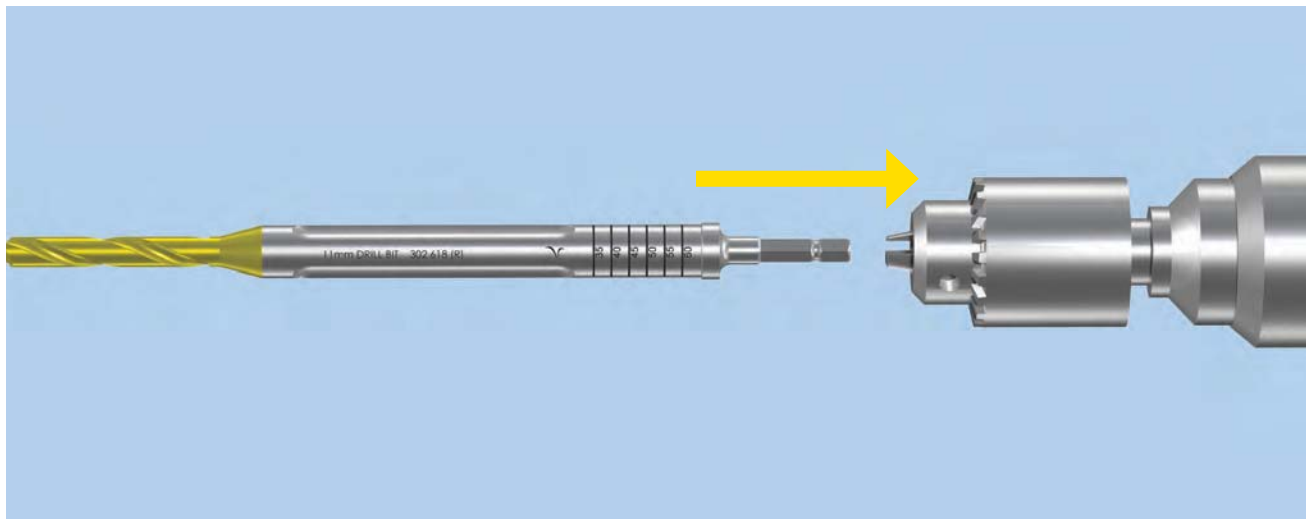

Surgical Technique (cont.)

14 Insert the Drill Bit over the Steinmann Pin and inside the #3 Dilator.

Note: Make sure the Drill Bit is parallel with the floor.

Slowly advance the Drill Bit across the joint and into the Ilium.

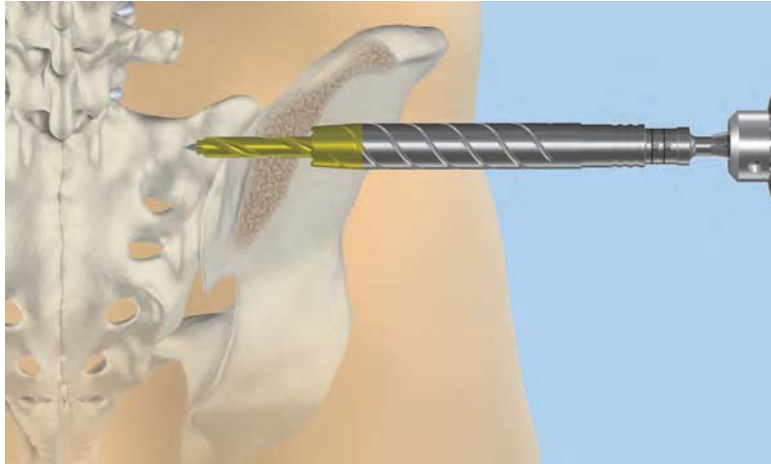

15 Insert the Blocking Pin into the rear of the power unit until flush with the Steinmann Pin. Hold the Blocking Pin in place while drill is being removed.

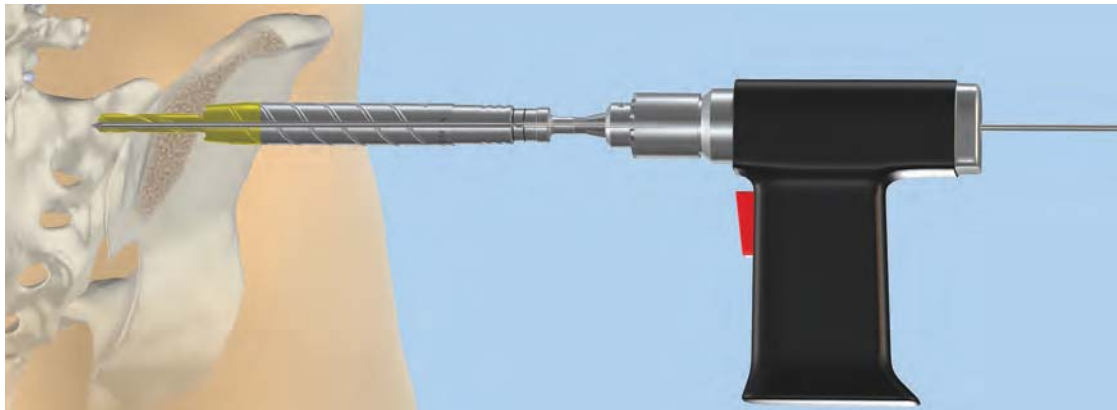

16 (Optional):

Before removing the Drill Bit, confirm the implant length by utilizing the #3 Dilator and markings on the Drill Bit.



Surgical Technique (cont.)

17 Decortication

After Drilling is complete, place the Decortication Joint Instrument into the #3 Dilator and advance until inside the sacroiliac joint. Once the instrument is in the desired location, slowly rotate the instrument to decorticate the joint.

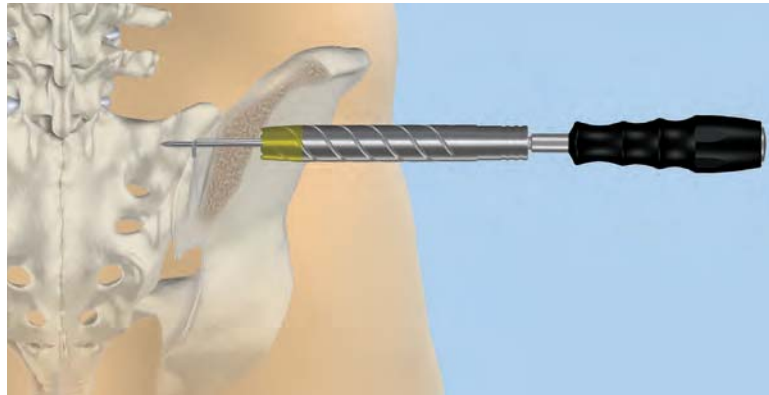

18 Implant Insertion

Select the appropriately sized implant and thread onto the Inserter Outer Sleeve. Rotate the Outer Sleeve clockwise until the implant is secure on the sleeve.

Place the Inserter Inner Shaft inside the Inserter Outer Sleeve, making sure the hex seats into the head of the implant.

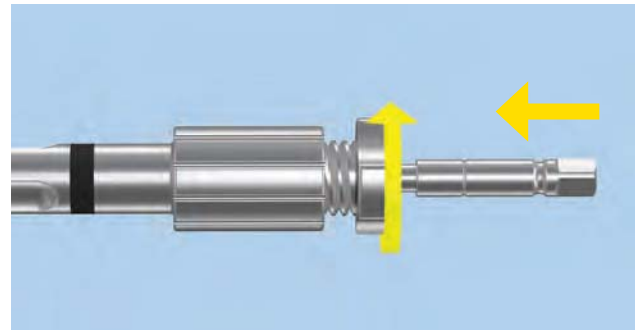
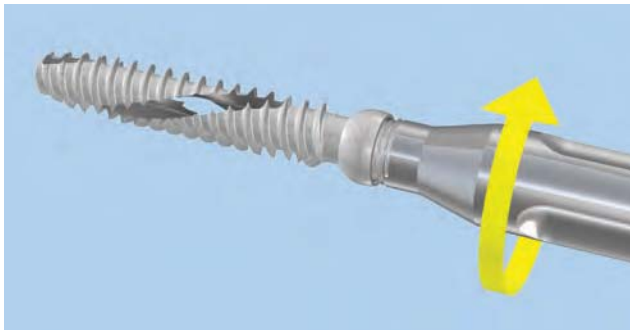

Once the Inner Shaft has been seated into the implant, lock by rotating the tri-lobe knob clockwise. Attach to the Ratcheting T-Handle.

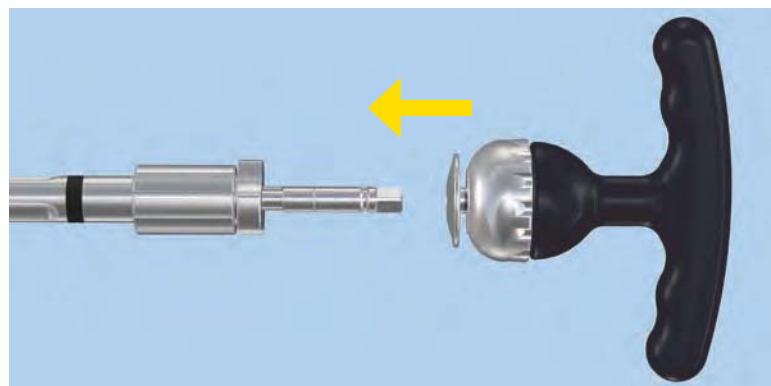

Surgical Technique (cont.)

Place the Final Driver assembly over the Steinmann Pin and advance the implant in a clockwise rotation to the desired depth.

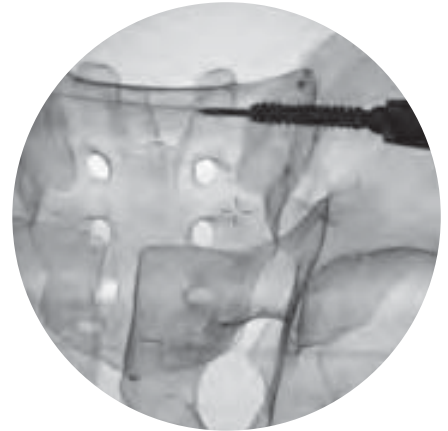
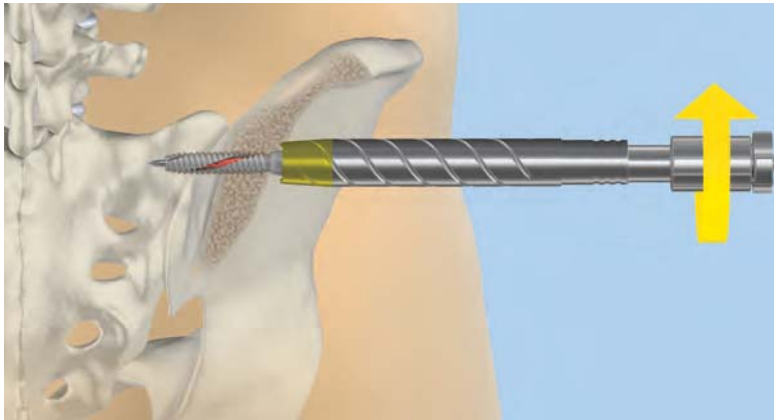

19 Instrument Removal

Insert the Blocking Pin into the rear of the power unit until flush with the Steinmann Pin.

Place the Ratcheting T-Handle in the neutral position and rotate the tri-lobe knob on the Inserter Inner Shaft counterclockwise to disengage and remove.

Rotate the Inserter Outer Sleeve counterclockwise until implant is fully disengaged.

Remove the Inserter Outer Sleeve and #3 Dilator.

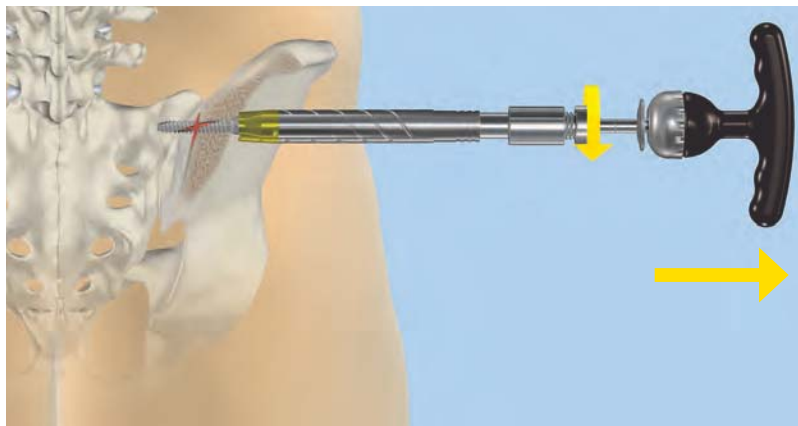

20 Pin Removal (optional)

Once all instruments have been removed and the implant is in the desired location, remove the Steinmann Pin.

Repeat steps 6-19 for additional implants.

Note: Do not remove the Steinmann Pin if utilizing the Fixed Pin Guide for second and/or third implant.

Surgical Technique (cont.)

21 Additional Implant Insertion

Select either the 14mm or 16mm Fixed Pin Guide.

Once desired size is selected, place the shorter tube over the Steinmann Pin.

Rotate the C-arm into a lateral view and confirm Steinmann Pin placement.

Rotate the longer tube of the Fixed Pin Guide to align at the desired location of the next implant.

Once the desired location has been determined, advance an additional Steinmann Pin through the longer tube of the Fixed Pin Guide into the Ilium.

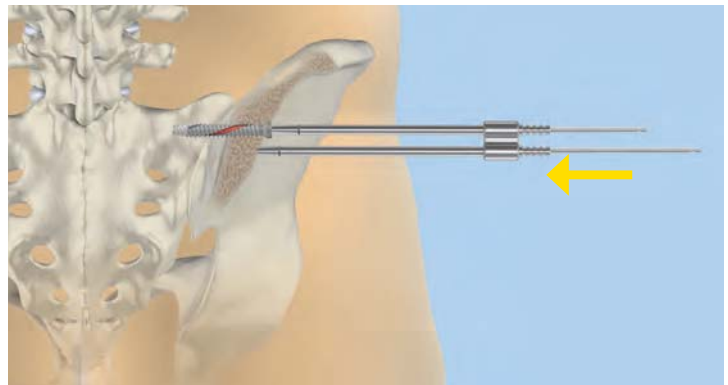
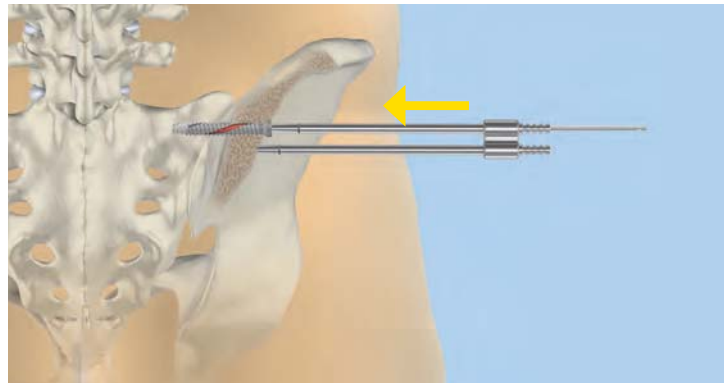

Verify that the implant is in the desired location by confirming in the Outlet and Inlet views.

Once confirmed, advance the Steinmann Pin to the desired depth.

Repeat steps 9-20 to complete additional implant insertions.

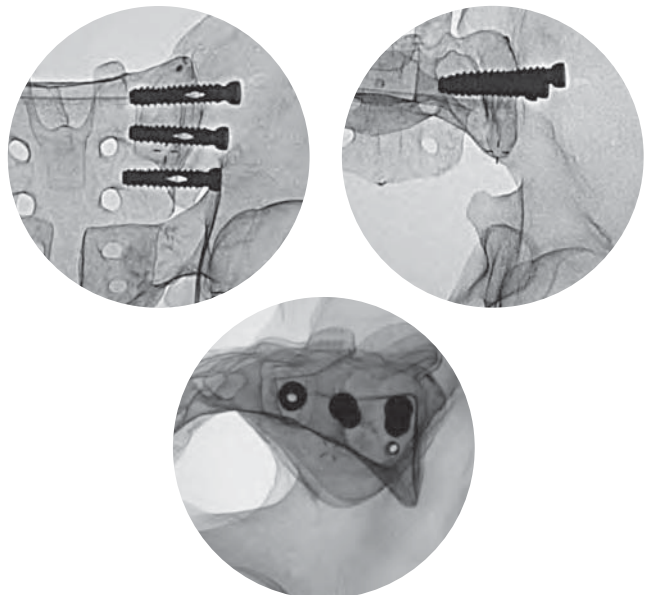
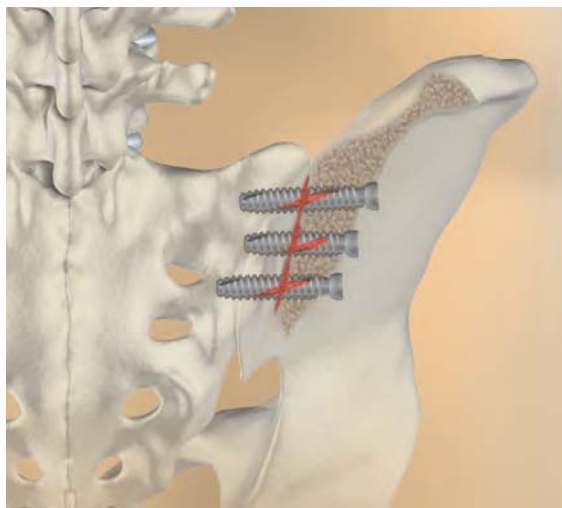

Surgical Technique (cont.)

22 Load Distribution Cap

If desired, a Load Distribution Cap can be attached to the proximal head of the implant.

First, select the appropriately sized Cap, 9.5mm or 11mm.

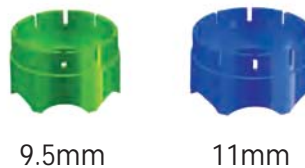

Slide the Cap from the distal tip toward the head of the implant with the serrated edge facing towards the distal tip.



Advance the Cap until it fully covers the head of the screw.

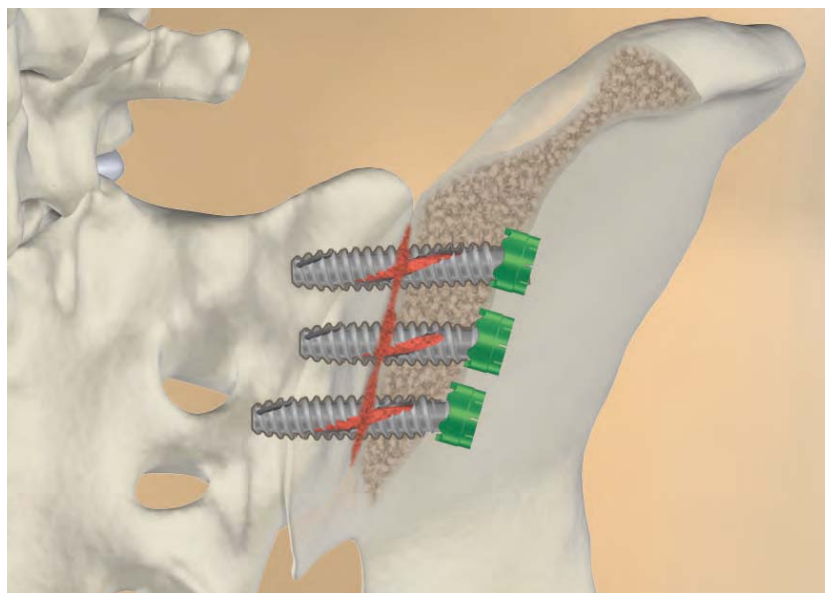
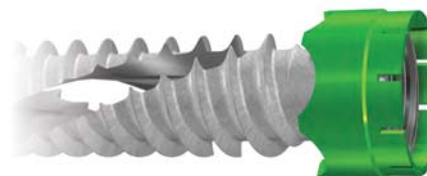

Surgical Technique (cont.)

23 Bone Graft Integration (optional)

Place the Ratcheting T-Handle in the neutral position and rotate the tri-lobe knob counterclockwise to disengage and remove the Inner Shaft.

Once the Inner Shaft is removed, carefully remove the Steinmann Pin.

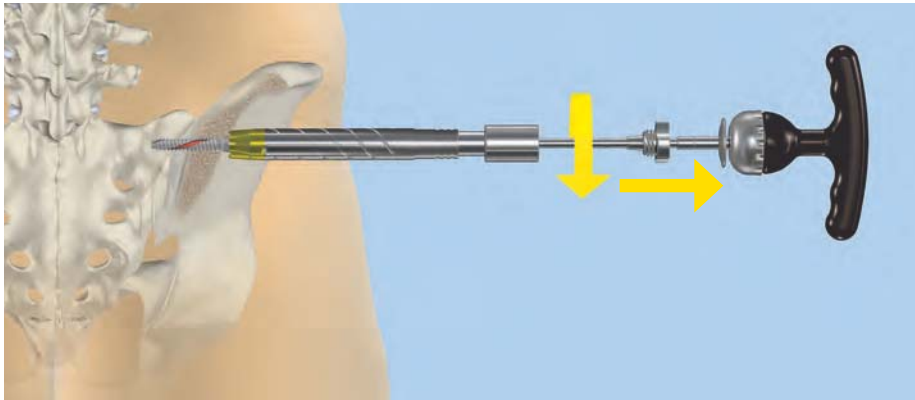

Once the Steinmann Pin and Inner Shaft are removed, select the preferred grafting material and insert into the Outer Sleeve.

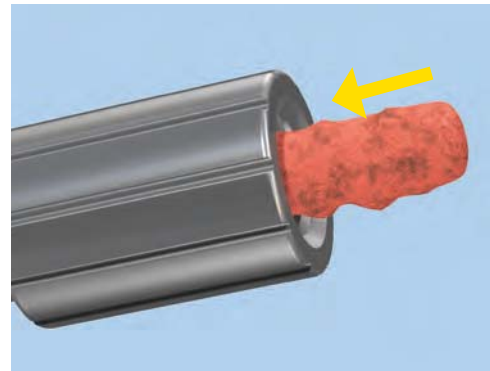
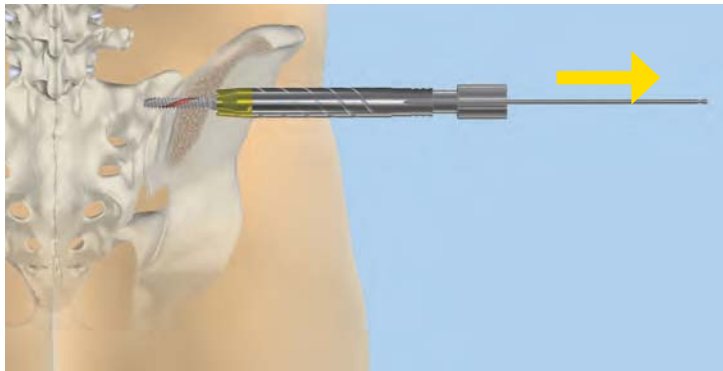

Insert the Bone Graft Packer into the Outer Sleeve and advance until it interfaces with the implant.

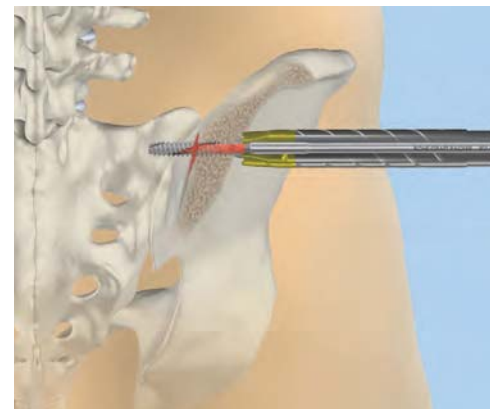
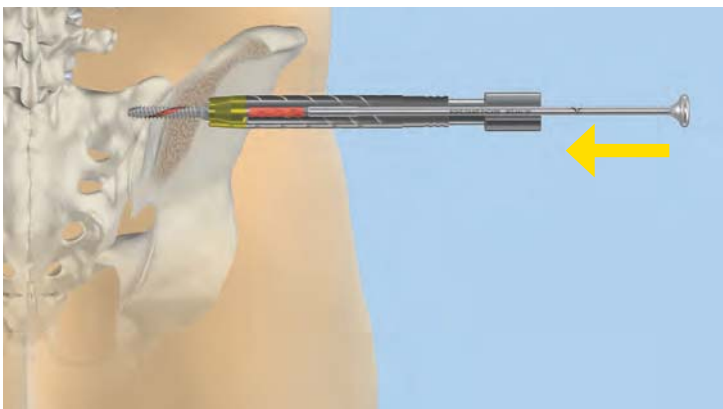

Implant Removal Instructions

24 Removal

In the case of a removal, first position the C-arm in a lateral view and identify the implant to be removed.

Once the implant has been identified, make a small 1-2cm incision in the desired location.

Select a Steinmann Pin and reinsert the Pin through the center of the implant.

Place the #1, #2 and #3 Dilators in succession over the Steinmann Pin until secure on the Ilium.

Remove inner Dilators, #1 & #2.

Slide the Inserter Outer Sleeve over the Steinman pin and into the #3 Dilator. Rotate the Outer Sleeve clockwise until the implant is secure on the sleeve. Place the Inserter Inner Shaft inside the Inserter Outer Sleeve making sure the hex seats into the head of the implant. Once the Inner Shaft has been seated into the implant, lock by rotating the tri-lobe knob clockwise.

Set the Ratcheting T-handle to the reverse ratcheting position and rotate counterclockwise until implant is removed.



Instrument / Implant Guide

BLOCKING PIN, 302.627



STEINMANN PIN - SEMI-BLUNT, 302.615



STEINMANN PIN - SHARP, 302.609



BONE GRAFT PACKER, 302.641



#1 DILATOR, 302.610



#2 DILATOR, 302.611



#3 DILATOR, 302.612



STEINMANN PIN DEPTH GAUGE, 302.622



14mm FIXED PIN GUIDE, 302.630.14



16mm FIXED PIN GUIDE, 302.630.16



JOINT DECORTICATION INSTRUMENT, 302.640



INSERTER INNER SHAFT, 302.605A



INSERTER OUTER SLEEVE, 302.605B



RATCHETING T-HANDLE, 302.639



DILATOR GUIDE HANDLE, 302.603



Instrument / Implant Guide (cont.)

9.5mm DRILL BIT, 302.617



SLIDE HAMMER, 302.637



11mm DRILL BIT, 302.618



MALLET, 302.638



9.5mm DIAMETER IMPLANTS

- 9.5mm x 35mm, 900.095.35
- 9.5mm x 40mm, 900.095.40
- 9.5mm x 45mm, 900.095.45
- 9.5mm x 50mm, 900.095.50
- 9.5mm x 55mm, 900.095.55
- 9.5mm x 60mm, 900.095.60

9.5mm LOAD DISTRIBUTION CAP

- 9.5mm, 900.095

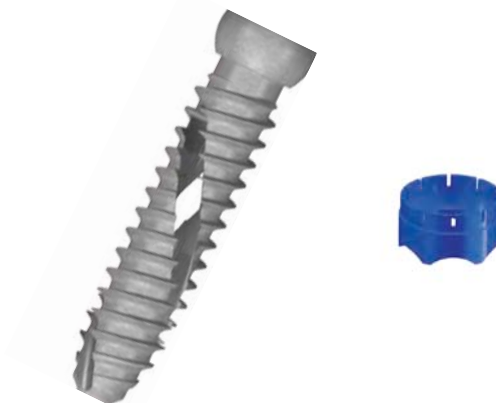

11mm DIAMETER IMPLANTS

- 11mm x 35mm, 900.11.35
- 11mm x 40mm, 900.11.40
- 11mm x 45mm, 900.11.45
- 11mm x 50mm, 900.11.50
- 11mm x 55mm, 900.11.55
- 11mm x 60mm, 900.11.60

11mm LOAD DISTRIBUTION CAP

- 11mm, 900.11



©2016 Alevio, LLC. All rights reserved. Patents Pending.

WARNING: This product has labeling limitations.
See Package Insert for details.

CAUTION: Federal Law (USA) restricts this device to sale by
or on the order of a physician.

Document Control # FRM-002.1, Rev A

SiCure® & Alevio® are registered trademarks of Alevio, LLC. 2870 Old Rocky Ridge Rd., Suite 200 Birmingham, AL 35243 P:205.783.5778 F:205.783.5780 www.aleviospine.com