



# VENUS<sup>®</sup> SCOLIOSIS

Scoliosis System



The VENUS® Scoliosis System was specially designed for the correction and stabilisation of the spine in particularly complicated anatomies. The system complements the innovative design features of the Venus® Screw Rod fixation system. The Deformity Tower contained in the VENUS® Scoliosis System is used for the gentle correction and reduction of three-dimensional deformities, including kyphosis or scoliosis. The correction can be performed on multiple levels in parallel.

The transparent and clearly arranged instruments increase the handling safety of common operating methods, with demonstrably high biomechanical stability.

## Implants for scoliosis surgery

The extensive range of different pedicle screws and compatibility with other add-on modules, for example the long head screw system, maximises the surgeon's intraoperative flexibility. This ensures you achieve a safe and stable construction in every situation.

### safe

- Quick and soft inclusion of the rods
- Gentle correction
- Inclusion of over-contoured rods possible
- Top loading system for ease of use

### anatomical

- Low profile

- Self-tapping thread design without traumatising cutting flutes
- Parallel correction on several levels

### transparent

- Colour-coded screws
- Clearly arranged and simple instruments

### stable

- Increased stability with reduced risk
- Immediate and lasting stability
- Tension-free installation due to polyaxial connection
- Load-optimised screw shaft design

### flexible

- Versatile application and techniques
- Large selection of implants
- Different spinal segments
- Optimum adaptability to anatomy
- Can be combined with all VENUS® implants

# VENUS®



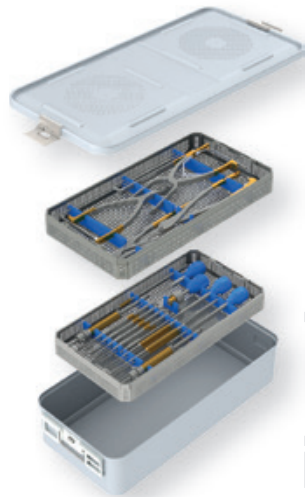

Fixation



Fixation

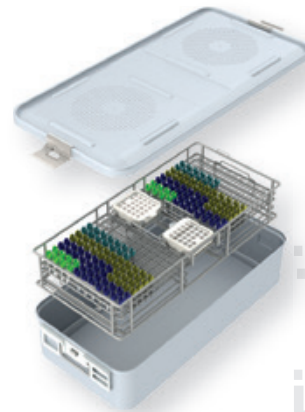

Fixation



Hooks

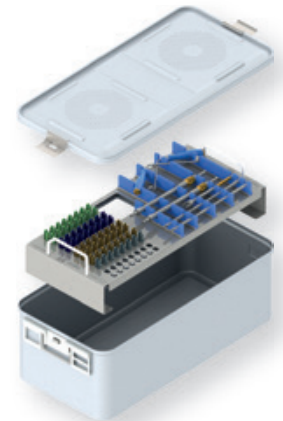

Reduction

## Product-specific advantages

- Modular system
- Gentle reduction
- Optimal osseointegration
- Self-tapping thread
- Maximum biomechanical stability

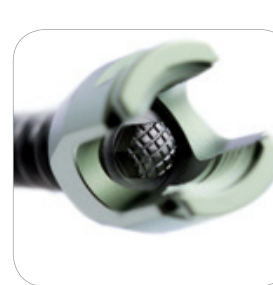
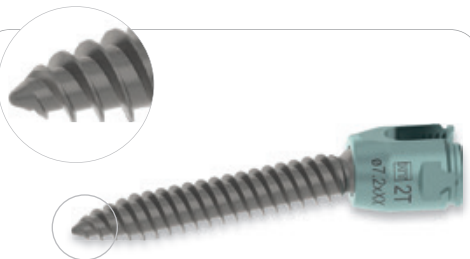



### Preparing the pedicle

Set the pedicle insertion point. Open the pedicle canal using the awl.

**Note:**

The awl is available with and without stop and also in cannulated form. The variants of the Awl without stop should only be used for pediculation. The deeper the preparation, the larger will be the core hole at the entry point.



### Awling and probing

The pedicle canal is awled. Using light pressure, the awl is advanced (Pedicule Probe) into the pedicle canal carefully in half rotations.

**Note:**

There are two types of pedicle awls available: straight and curved.



### Tapping

All pedicle screws are self-tapping. However, we recommend using thread taps in cases where the bone structure is very strong. These are available for all screw diameters.

**Note:**

For 6T screws we offer special thread taps to prepare cancellous and cortical thread. We always recommend using the thread tap that corresponds to the diameter of the pedicle screw.



# VENUS®

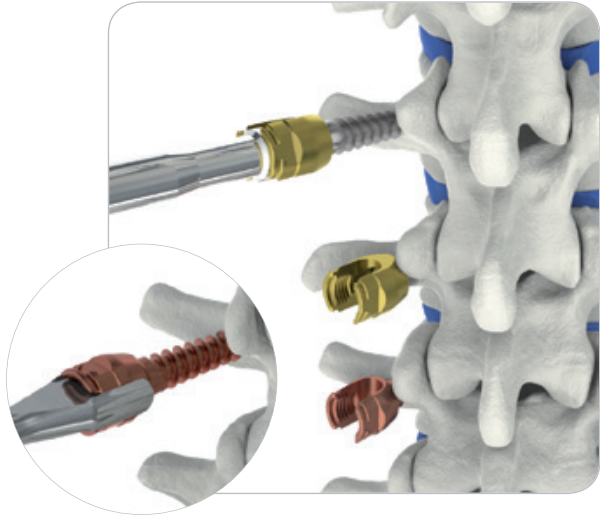

### Inserting the pedicle screws

**Monoaxial screw:**

The tip of the monoaxial screwdriver clicks into the screw head and secures the screw. The screw is screwed into the pedicle canal.

**Polyaxial screw:**

First, insert the screwdriver tip (inner shaft) into the screw head and attach it to the outer hexagon of the thread shaft. Then connect the outer guide to the screw head by screwing it into the inner thread of the screw head. When using the polyaxial screwdriver, you must push the locking adapter forward

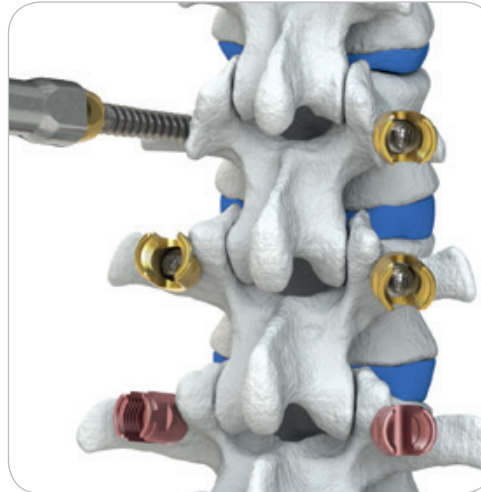

### Inserting the pedicle screws II

and lock it into the connection geometry. You must also check the button on the locking adapter. (See user information on the polyaxial screwdriver).

When using the polyaxial screw inserter, secure the pedicle screw and then feed the protection sleeve over the screw head. The screw is screwed into the pedicle canal.

**Note:**

If desired, use the reposition screw driver afterwards to correct the screw-in depth.

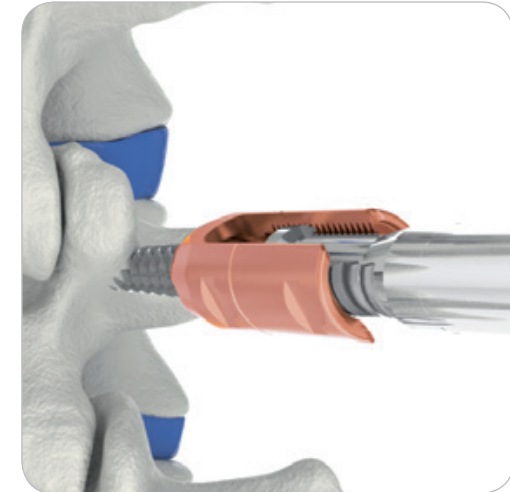

### Inserting the long headed screws (optional)

In specific situations, such as spondylolisthesis, it might be indicated to use reduction screws. The extended screw head allows the reduction and facilitates the connection between rod and screw in difficult anatomic and surgical conditions. Insert the screws the same way as the standard pedicle screws.

**Note:**

Screw the inner screwdriver shaft of the reduction system into the guide of the polyaxial screw driver provided for this purpose.

## Surgical Technique

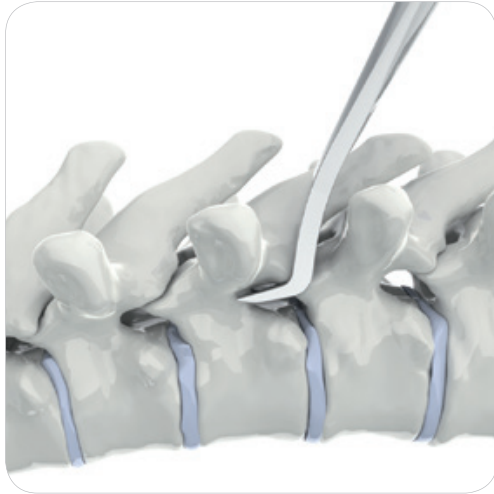

### Preparing the pedicle hook position (optional)

Pedicle hooks are available in different sizes and for different applications. Pedicle hooks can be used only in the thoracic region, in the cranial direction. For this, the caudal facet joint is resected at a right angle. Below this, the cranial articular facet of the vertebra positioned caudally of it is visible.

The pedicle is palpated using the instrumentation by undercutting the facet of the cranial vertebra on the facet which has been rendered visible.

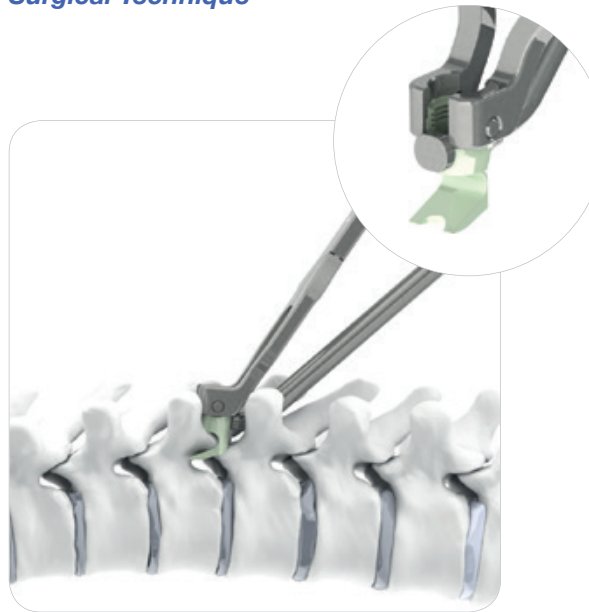

### Inserting the pedicle hook (optional)

In order to facilitate the insertion of the pedicle hook, remove a small part of the lower facet using an osteotome. Lock the hook holder in the side instrument holder of the hook and then push the hook impactor into the rod holder of the hook. With this combination of instruments, the pedicle hooks can be easily pressed into the pedicle hook position. Assist with gentle hammer blows if need be. Move the hook holder laterally and cranially to check for the optimum position. Do not press medially.



### Preparing the lamina hook position (optional)

Lamina hooks are available in different sizes and for different applications. Lamina hooks can be used in both the thoracic and lumbar regions (in the caudal-cranial, cranial-caudal direction and in the transverse processes). The hook position is prepared on the transverse process by means of cranial bypass with the lamina finder. For caudal setting of lamina hooks, following a partial flavectomy, the hook is placed in a supra laminar, supra thoracic or lumbar position. If necessary, the spinous processes must be shortened until the ligamentum flavum is visible.

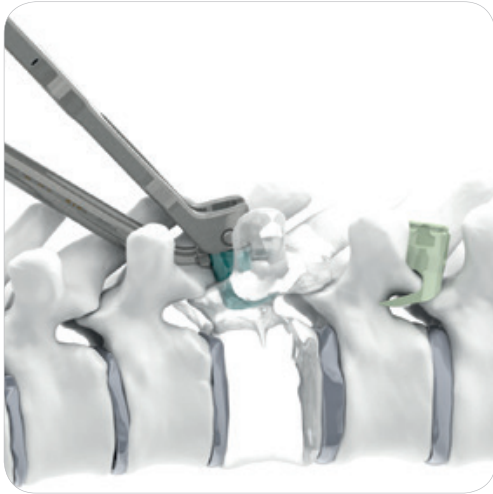

### Inserting the lamina hook (optional)

For a safe identification and preparation of the hook position, the ligamentum flavum is removed with a rongeur up to a point where the dura is visible. The hooks are inserted with the instrument combination hook holder and hook impactor. Make sure that the hook is not too deep or presses on the spinal cord.



### Determining rod length and cutting rods to length

Set the rod length. A phantom rod is contained in the instruments to make it easier to set the rod length.

Widen the rod cutter so that the rod holders stay open. Depending on the relative diameter, slide the rod through the appropriate holder. With short, sharp pressure, shorten the rod to the intended point.

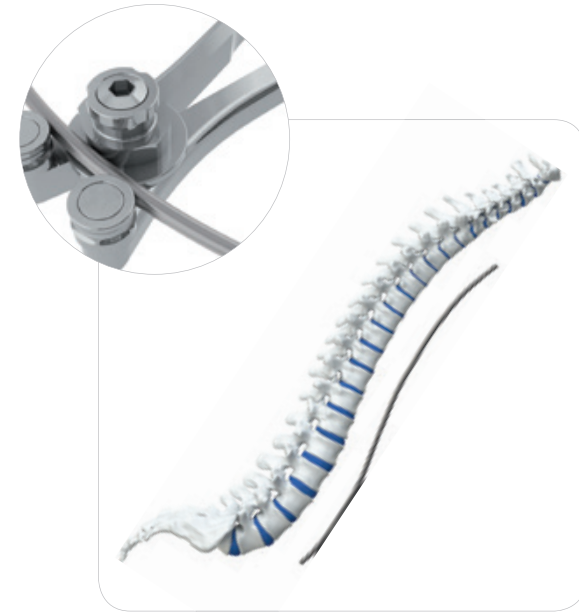

### Bending the rod

Bend the rods with rod benders to fit the corresponding radius. The bending radius can also be set on the instrument by adjusting the bending roll. Insert the rod in the screw heads using the rod inserter, if necessary with manual support.

## Using the deformity tower

The deformity tower is used for the gentle repositioning of individual segments or for pressing down the rod in the screw heads.

To place the implant, first open the gold fixing screw.

Guide the deformity tower over the rod and implant head until distinct resistance is noticeable. Then lock the connection between the instrument and the implant by turning the golden fixing screw. The instrument is now firmly connected to the implant.

Now turn the transport screw clockwise to move the segment in the direction of the rod or to move the rod into the final position of the screw heads.

The positioning of the rod can be performed in steps via multiple deformity towers arranged side by side.

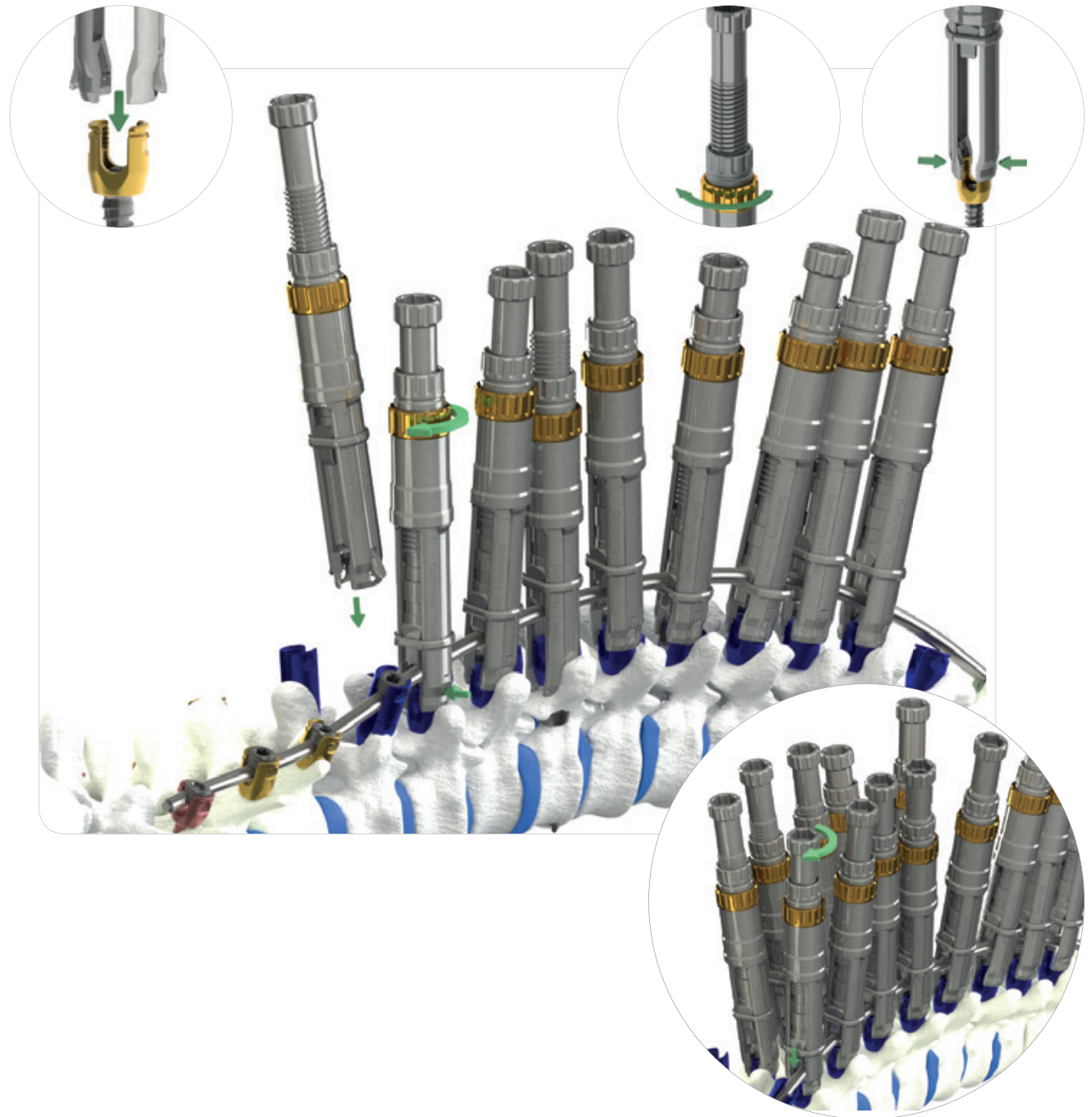



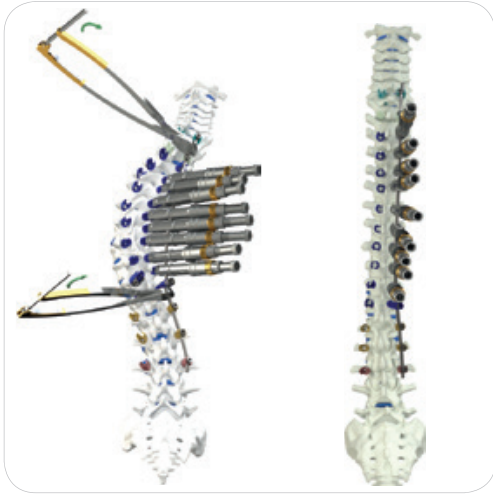

## Derotation

The spine derotation can be performed by placing the derotation forceps directly at the rod. For this, the rod is inserted at approx. 90° to the final sagittal alignment. The rod is positioned in the proximal and distal screw heads with the screwed in transport screw of the deformity tower. Thereafter, the derotation can be performed using forceps.

### Note:

For derotation, the relevant segments must be sufficiently mobilised.

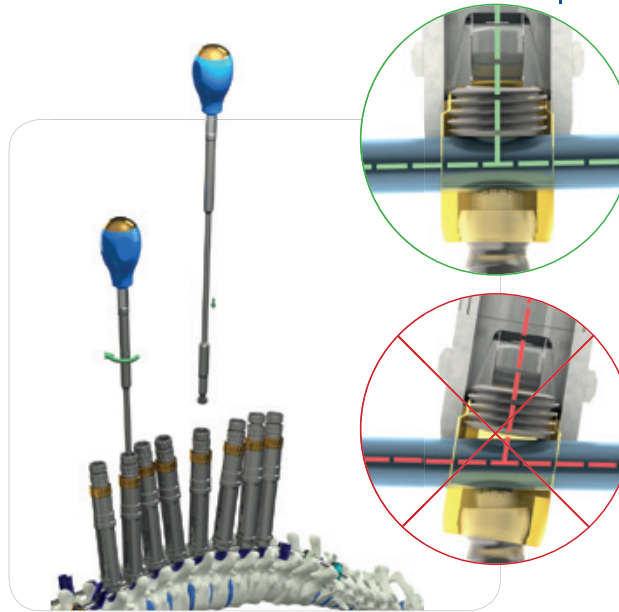

## Pre-fixing the rod

After correction of the misalignment, fix the rod in the screw heads with the set screw using the setscrew inserter.

### Caution:

The deformity tower should be pre-fixed at a right angle to the rod. Cross-threading can result in loosening of the screw-rod connection! The final torque is applied using the set screw driver and the torque driver.



## Using the approximator

Optionally, in addition to the deformity tower, the approximator can also be used to push the rod into the screw head. The instrument is driven through the implant head until distinct resistance is noticeable. Lock the instrument onto the implant by tilting the locking lever in the direction of the handle cage. Carefully turn the handle clockwise. Reduction of the segment, if necessary, with X-ray checks. Insert the set screws and fix the rod in the screw head.

### Note:

The approximator and the screw head must then be connected gently and without force. If in doubt, remove the approximator and reposition it. Ensure that the implant rod, when using the approximator, overlaps on the screw head on both sides by at least 5 mm, so that the reduction forks are in full contact with the rod.



### Using the persuader (optional)

If required, the persuader forceps style can also be used to reposition the moved spine or to position the rod in the screw head. The instrument is driven through the implant head until distinct resistance is noticeable. Press the handle to lock the instrument onto the implant. Connection is guaranteed as soon as the first tooth of the toothed rod is locked onto the anterior handle. Pressing the handle further repositions the spine and positions the rod into the screw head rod holder. The position is maintained by the toothed rod. Ensure that the implant rod, when using the persuader, overlaps on both sides of the screw head by at least 5 mm, so that the reduction fork is in full contact with the rod.



### Using the rocker

Using the rocker the rod can be guided into the rod notches of the implant. The rocker is positioned on the screw head by inserting the fork ends into the lateral grooves of the screw head. Crank the rocker shaft until it sits on the rod. Then continue to crank it carefully, making visual and, if need be, x-ray checks until the rod and the screw head are interlocked. Now insert the set screws and fix the rod in the screw head.

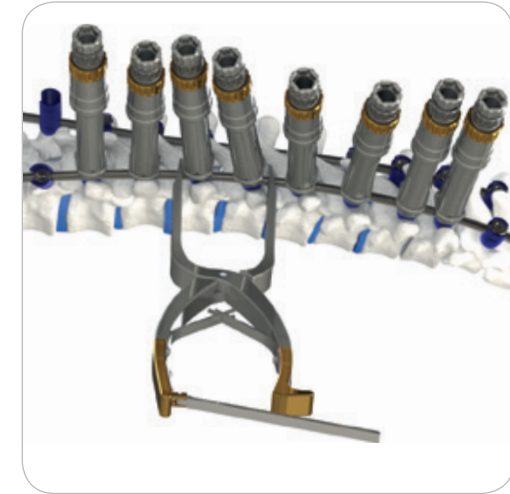

### Compression / Distraction

Position the compressor or distractor on the screw heads or placed deformity towers and carry out the compression or distraction procedure until the desired position has been achieved. Insert the set screws using the setscrew inserter. To ensure the compression or distraction result, tighten with the setscrew driver.

**Note:**

The set screws must not be fully tightened during this manoeuvre. If necessary, carefully loosen the set screws using the setscrew driver.

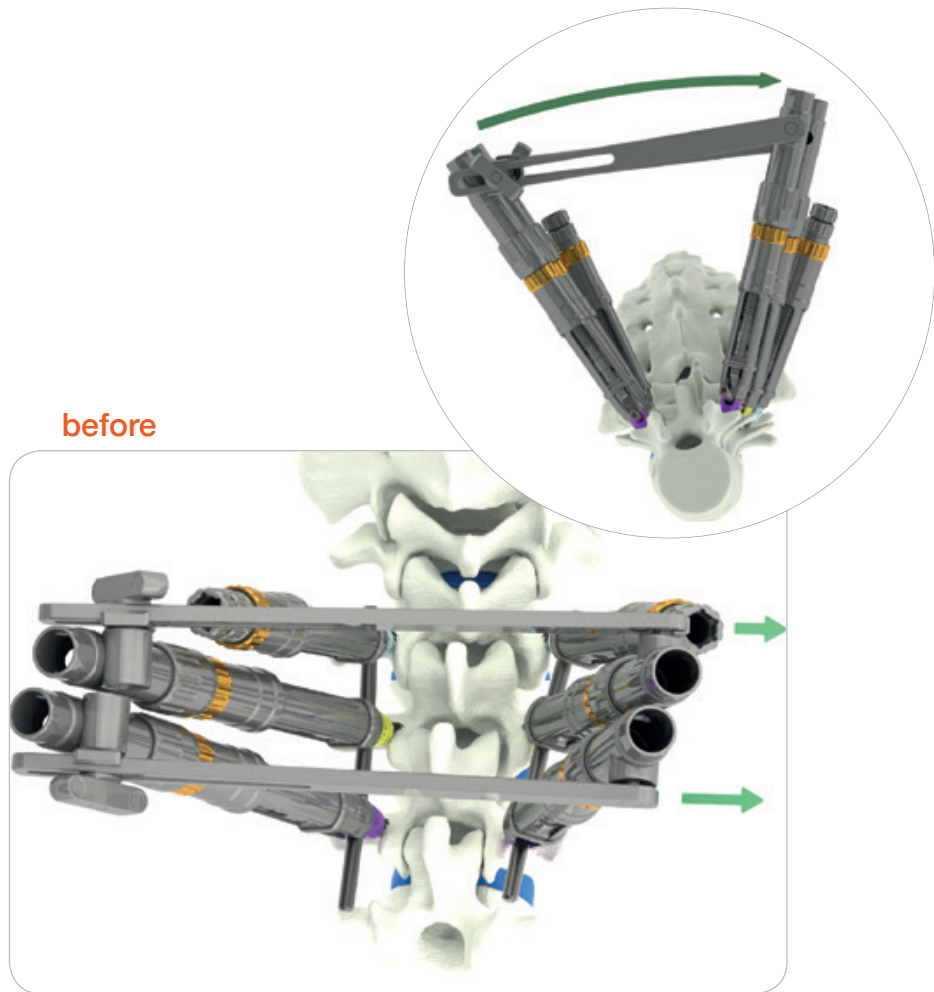

before

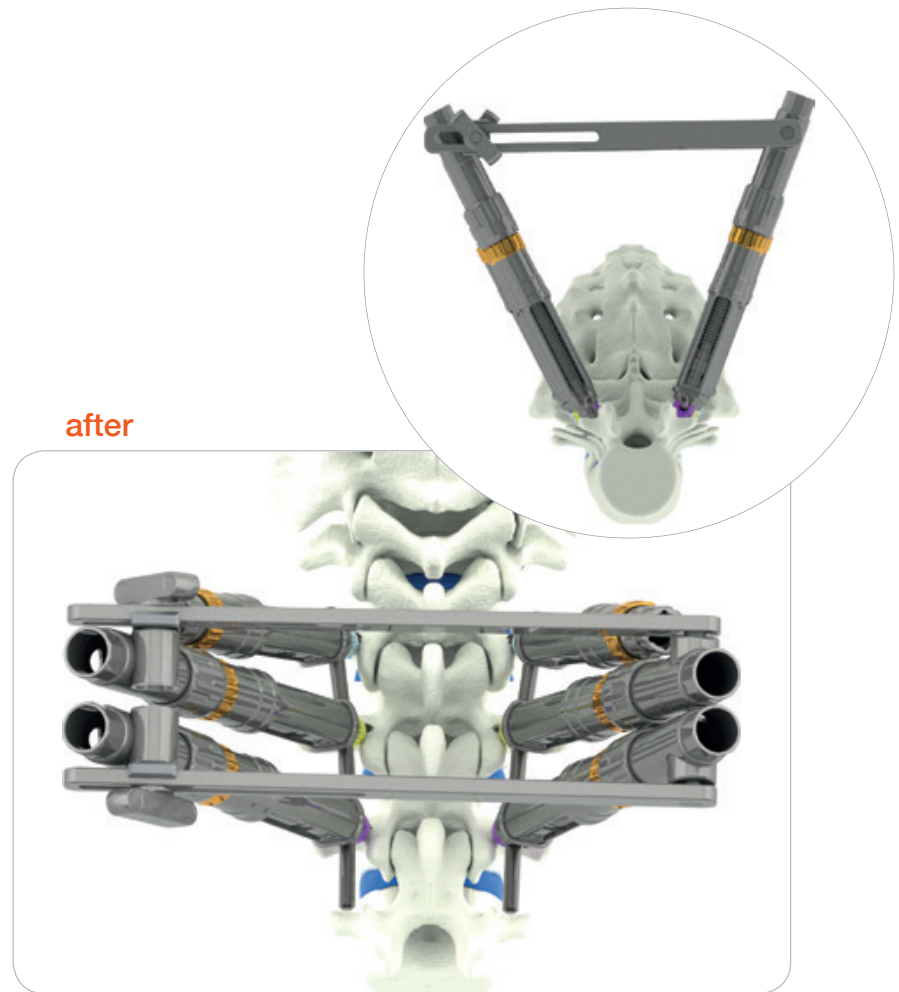

after

### Using the DT derotation extension

With the DT derotation extension structure the vertebrae can be derotated in sections. For this, the mobility of the poly-axial heads in the transversal plane is blocked, allowing for a derotation of the vertebrae by carefully turning the construct.

**Caution:**

Excessive force can damage soft tissue structures and/or blood vessels, if necessary, also pull out and/or break up the screws from the pedicles.

## Surgical Technique



### Fitting the derotation sleeves

Insert the derotation sleeves (DT derotation sleeve DT and DT derotation sleeve wjoint) over the transport screw of the deformity tower, until it stops and then lock it by turning the stop sleeves at the derotation sleeves in clockwise direction.

**Caution:**

Before placing the derotation sleeve on the deformity tower, the stop sleeve must be opened (turn anti-clockwise).

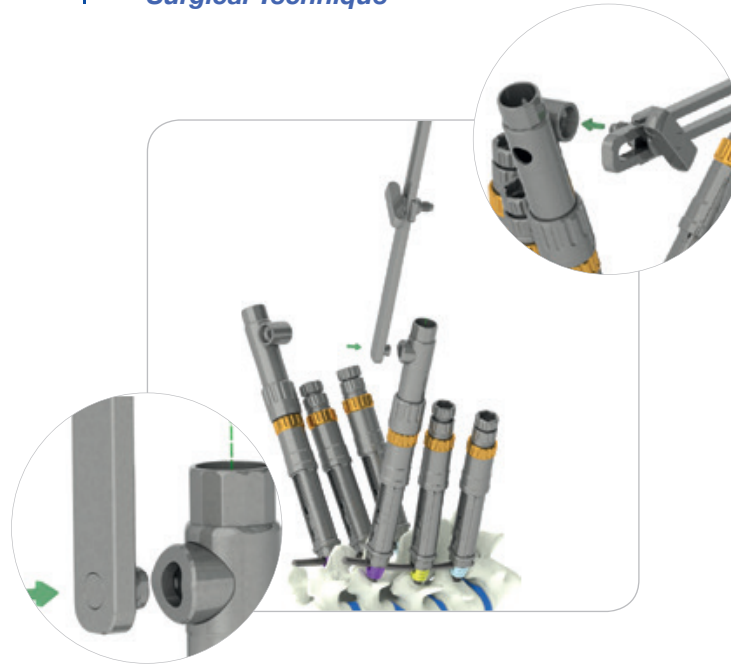

### Fitting the connector rail

The axially aligned connector rail (DT connector rail) must be guided into the holder of the derotation sleeve (DT derotation sleeve wjoint) and turned in the direction of the opposite derotation sleeve (DT derotation sleeve). By twisting, the rail is secured against accidental loosening. Screw the wing screw into the holder in clockwise direction.

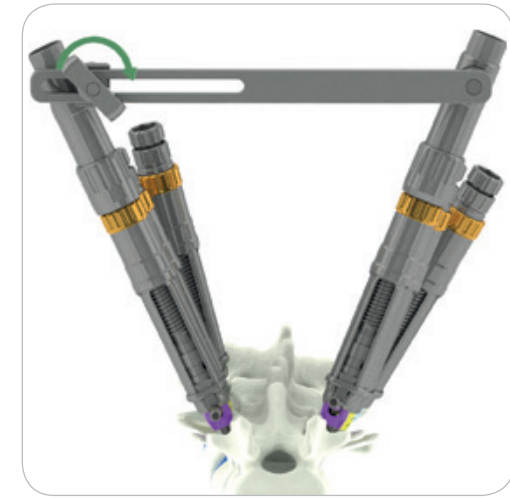

### Using the DT derotation extension

Using the wing screw, the mobility of the structure in the rotation level can be blocked and released against. Align the sleeves and tighten the wing screw! The vertebrae can now be derotated by carefully moving the sleeves.

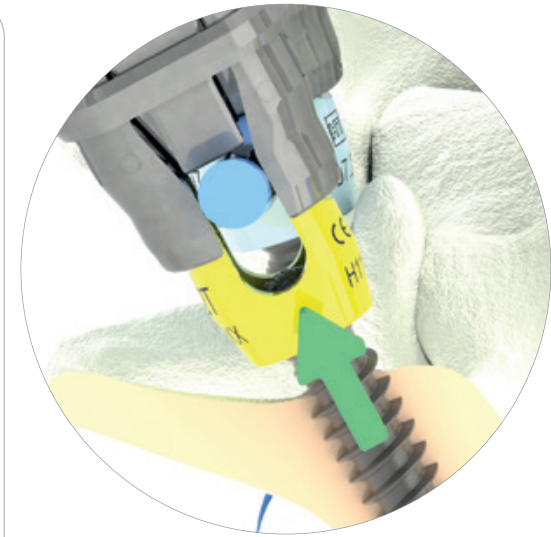
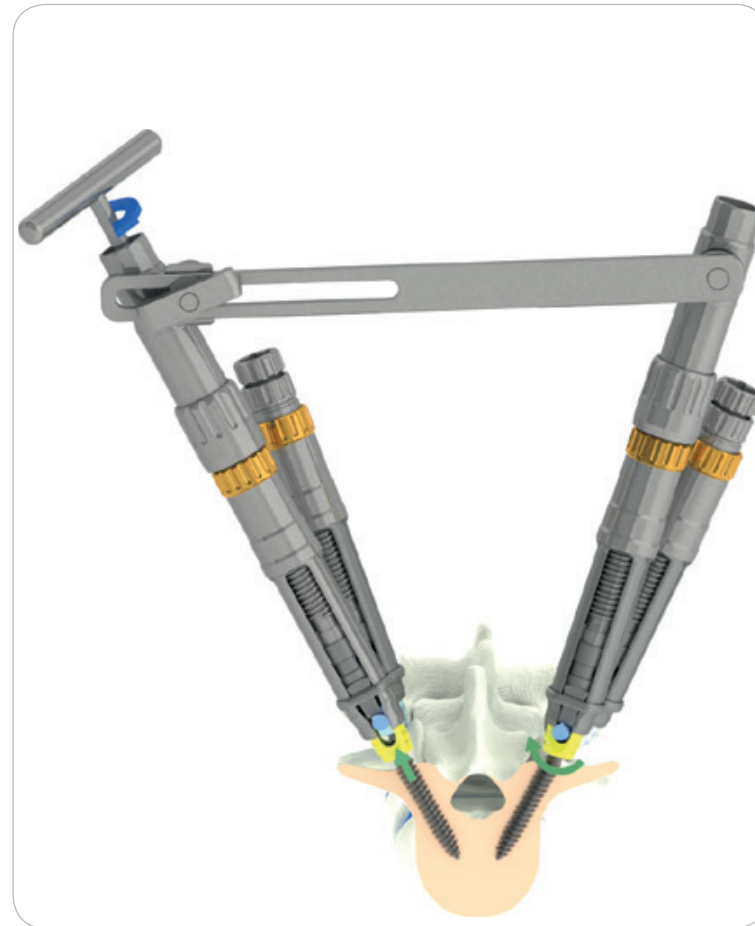

### Using the key deformity tower

Insert the key deformity tower from above through the relevant derotation sleeve into the Torx profile of the transport screw of the deformity tower. By turning the key clockwise the segment can be moved in the direction of the rod or the rod can be moved into the final position of the screw head. This way, the derotation of individual segments is supported by pressing down the rod or by pulling the poly-axial screw. The entire structure, including the vertebrae is rotated over the counter bearing (rod on the opposite side). The derotation or the reduction can be performed in steps with multiple deformity towers arranged side by side.

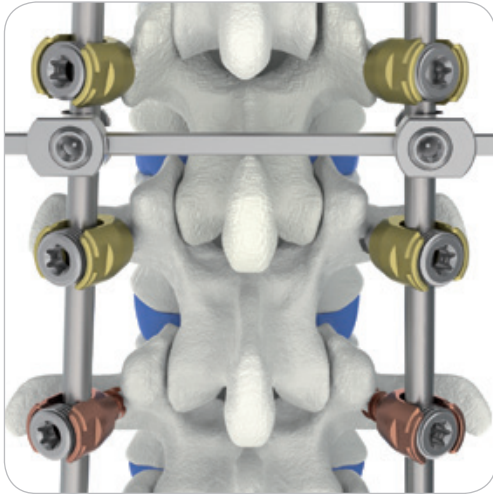

### Transverse connector

Attach a transverse stabiliser hook with the help of the transverse connector inserter. Connect the second hook with the transverse connector rod which is inserted via the transverse connector rod holder and attach it to the second rod of the instrument. Align the elements and connect the transverse connector hooks using the transverse connector rod. Screw the set screws all the way into the transverse connector hook using the setscrew driver.

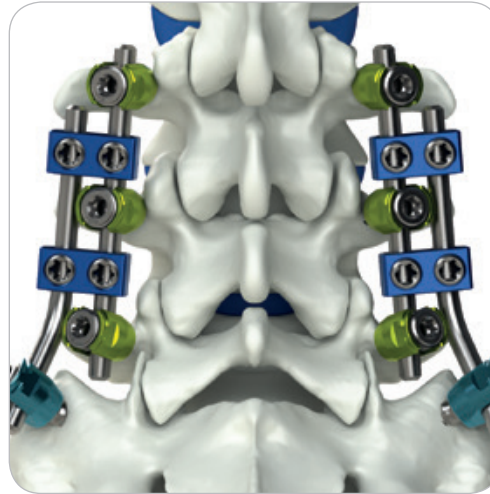

### Special structures (optional)

The use of additional implants (lateral, domino, parallel connectors) allows special structures for specific requirements, e.g. an ilium screw joint.

**Note:**

In order to ensure the stability of the overall structure, at least two of these implants must be inserted on each side when using the parallel connector.

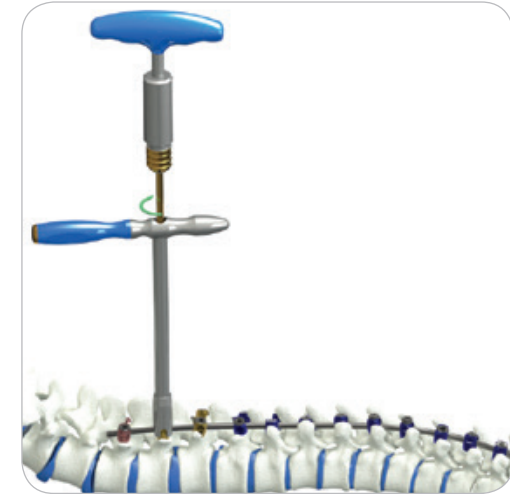

### Subsequent tightening

The counter holder is guided over the screw head and pushed all the way onto the rod. Ensure that the notches at the distal end of the counter holder take up the inserted rod. Couple the torque driver and the torque wrench. Place the combined instruments through the fitted counter holder. Tighten the set screw in a clockwise direction. Follow the same approach for all other set screws.

**Note:**

The full torque of 12 Nm is reached when you hear a clicking sound in the torque wrench. To achieve maximum stability ensure that the final torque is only applied with the torque driver, once all reduction and correction manoeuvres have been completed.

## Surgical Technique

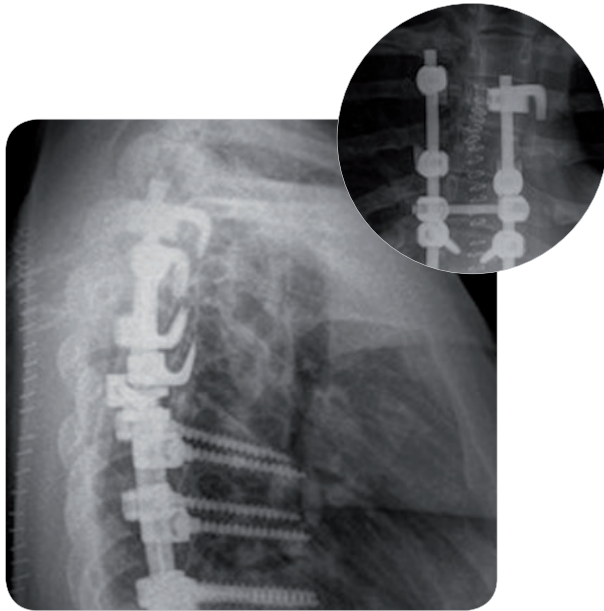

### Final check

Final check of the structure with X-ray control images taken in two planes.



### Final structure

Cleanse the surgical area and close the wound.



# VENUS<sup>®</sup>

Monoaxial screw

Item no.	Description	Diameter	Length	
VL-PMS	Polyaxial / Monoaxial Setscrew			
VL-MS-5-4830	Monoaxial Screw	4.8mm	30mm	Ø 4.8
VL-MS-5-4835	Monoaxial Screw	4.8mm	35mm	
VL-MS-5-4840	Monoaxial Screw	4.8mm	40mm	
VL-MS-5-4845	Monoaxial Screw	4.8mm	45mm	
VL-MS-5-5525	Monoaxial Screw	5.5mm	25mm	Ø 5.5
VL-MS-5-5530	Monoaxial Screw	5.5mm	30mm	
VL-MS-5-5535	Monoaxial Screw	5.5mm	35mm	
VL-MS-5-5540	Monoaxial Screw	5.5mm	40mm	
VL-MS-5-5545	Monoaxial Screw	5.5mm	45mm	
VL-MS-5-5550	Monoaxial Screw	5.5mm	50mm	
VL-MS-5-5555	Monoaxial Screw	5.5mm	55mm	Ø 6.5
VL-MS-5-6535	Monoaxial Screw	6.5mm	35mm	
VL-MS-5-6540	Monoaxial Screw	6.5mm	40mm	
VL-MS-5-6545	Monoaxial Screw	6.5mm	45mm	
VL-MS-5-6550	Monoaxial Screw	6.5mm	50mm	
VL-MS-5-6555	Monoaxial Screw	6.5mm	55mm	
VL-MS-5-7240	Monoaxial Screw	7.2mm	40mm	Ø 7.2
VL-MS-5-7245	Monoaxial Screw	7.2mm	45mm	
VL-MS-5-7250	Monoaxial Screw	7.2mm	50mm	
VL-MS-5-7255	Monoaxial Screw	7.2mm	55mm	
VL-MS-5-7260	Monoaxial Screw	7.2mm	60mm	

Set screw





## 2T Polyaxial Screw

Item no.	Description	Diameter	Length	
4000024825	2T Polyaxial Screw	4.8mm	25mm	Ø 4.8
4000024830	2T Polyaxial Screw	4.8mm	30mm	
4000024835	2T Polyaxial Screw	4.8mm	35mm	
4000024840	2T Polyaxial Screw	4.8mm	40mm	
4000024845	2T Polyaxial Screw	4.8mm	45mm	
4000025525	2T Polyaxial Screw	5.5mm	25mm	Ø 5.5
4000025530	2T Polyaxial Screw	5.5mm	30mm	
4000025535	2T Polyaxial Screw	5.5mm	35mm	
4000025540	2T Polyaxial Screw	5.5mm	40mm	
4000025545	2T Polyaxial Screw	5.5mm	45mm	
4000025550	2T Polyaxial Screw	5.5mm	50mm	
4000025555	2T Polyaxial Screw	5.5mm	55mm	
4000026525	2T Polyaxial Screw	6.5mm	25mm	Ø 6.5
4000026530	2T Polyaxial Screw	6.5mm	30mm	
4000026535	2T Polyaxial Screw	6.5mm	35mm	
4000026540	2T Polyaxial Screw	6.5mm	40mm	
4000026545	2T Polyaxial Screw	6.5mm	45mm	
4000026550	2T Polyaxial Screw	6.5mm	50mm	
4000026555	2T Polyaxial Screw	6.5mm	55mm	
4000027235	2T Polyaxial Screw	7.2mm	35mm	Ø 7.2
4000027240	2T Polyaxial Screw	7.2mm	40mm	
4000027245	2T Polyaxial Screw	7.2mm	45mm	
4000027250	2T Polyaxial Screw	7.2mm </td <td>50mm</td>	50mm	
4000027255	2T Polyaxial Screw	7.2mm	55mm	
4000027260	2T Polyaxial Screw	7.2mm	60mm	

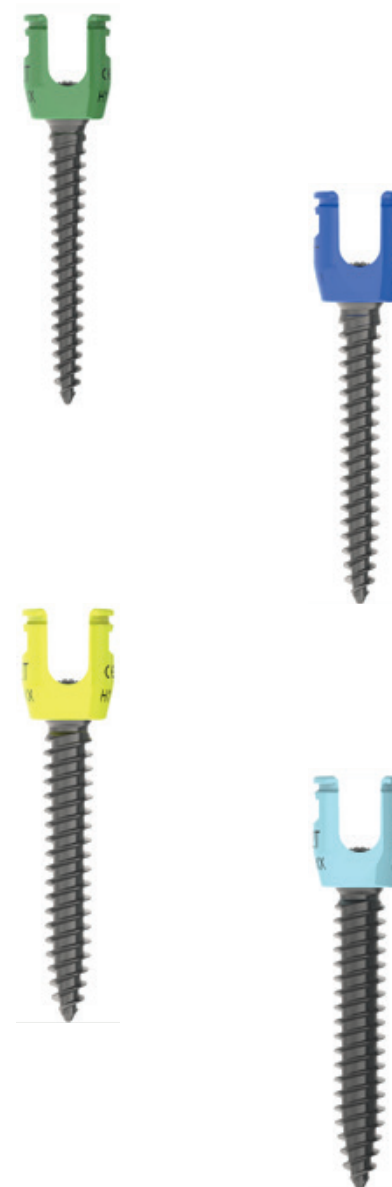

## Multiple threaded osteoporosis screws (6T screw)

Item no.	Description	
VL-PS2-5-4825	Polyaxial screw 6T 4.8 x 25 mm	Ø 4.8
VL-PS2-5-4830	Polyaxial Screw 6T 4.8 x 30 mm	
VL-PS2-5-4835	Polyaxial Screw 6T 4.8x35mm	
VL-PS2-5-4840	Polyaxial Screw 6T 4.8 x 40 mm	
VL-PS2-5-5525	Polyaxial Screw 6T 5.5 x 25 mm	Ø 5.5
VL-PS2-5-5530	Polyaxial screw 6T 5.5 x 30 mm	
VL-PS2-5-5535	Polyaxial Screw 6T 5.5 x 35 mm	
VL-PS2-5-5540	Polyaxial Screw 6T 5.5 x 40 mm	
VL-PS2-5-5545	Polyaxial Screw 6T 5.5 x 45 mm	
VL-PS2-5-5550	Polyaxial Screw 6T 5.5 x 50 mm	
VL-PS2-5-5555	Polyaxial Screw 6T 5.5 x 55 mm	Ø 6.5
VL-PS2-5-6525	Polyaxial Screw 6T 6.5 x 25 mm	
VL-PS2-5-6530	Polyaxial Screw 6T 6.5 x 30 mm	
VL-PS2-5-6535	Polyaxial Screw 6T 6.5 x 35 mm	
VL-PS2-5-6540	Polyaxial Screw 6T 6.5 x 40 mm	
VL-PS2-5-6545	Polyaxial Screw 6T 6.5 x 45 mm	
VL-PS2-5-6550	Polyaxial Screw 6T 6.5 x 50 mm	Ø 7.2
VL-PS2-5-6555	Polyaxial Screw 6T 6.5 x 55 mm	
VL-PS2-5-7240	Polyaxial Screw 6T 7.2 x 40 mm	
VL-PS2-5-7245	Polyaxial Screw 6T 7,2 x 45 mm	
VL-PS2-5-7250	Polyaxial Screw 6T 7.2 x 50 mm	
VL-PS2-5-7255	Polyaxial Screw 6T 7.2 x 55 mm	
VL-PS2-5-7260	Polyaxial Screw 6T 7.2 x 60 mm	



## Rods

Item no.	Description	Diameter	Length
VL-RS-5-15	Rod straight	5.5mm	150mm
VL-RS-5-20	Rod straight	5.5mm	200mm
VL-RS-5-25	Rod straight	5.5mm	250mm
VL-RS-5-30	Rod straight	5.5mm	300mm
VL-RS-5-35	Rod straight	5.5mm	350mm
VL-RS-5-40	Rod straight	5.5mm	400mm
VL-RS-5-45	Rod straight	5.5mm	450mm
VL-RS-5-60	Rod straight	5.5mm	600mm



## Scoliosis Rods

### CoCr-Rod 5.5mm

The higher level of rigidity of the cobalt-chrome bar compared to the titanium rod allows for better correction options, for example in cases of major deformities.

Item no.	Description	Diameter	Length
1001090145	CoCr Rod 450mm	5.5 mm	450 mm



## Transverse connector

Item no.	Description	Length
1001050500	Transverse Connector Hook	
VL-TR-50	Transverse Connector Rod	50mm
VL-TR-60	Transverse Connector Rod	60mm
VL-TR-70	Transverse Connector Rod	70mm
VL-TR-80	Transverse Connector Rod	80mm
VL-TR-90	Transverse Connector Rod	90mm
VL-TR-100	Transverse Connector Rod	100mm



*Instruments*

Item no.	Description
055068	Awl
1001010079	Cannulated Awl 30
1001010047	Awl without Stop
1106011101	Cannulated Awl Without Stop
1101010006	Goniometer Awl
055217	Pedicle Probe
055271	Pedicle Probe Curved
055067	Pedicle Sounder
1001010059	Pedicle Sounder Fine



Item no.	Description	
1006011203	Cannulated Tapping	optional
1006011200	Cannulated Tap 4.8	
1006011201	Cannulated Tap 5.5	
1006011202	Cannulated Tap 6.5 Cannulated Tap 7.2	
1010030003	Tapping 6T	
1010030000	6T Tap 4.8	
1010030001	6T Tap 5.5	
1010030002	6T Tap 6.5 6T Tap 7.2	
1010030015	Cannulated Tapping 6T	optional
1010030012	Cannulated 6T Tap 4.8	
1010030013	Cannulated 6T Tap 5.5	
1010030014	Cannulated 6T Tap 6.5	
1010030010	Cannulated 6T Tap 7.2 Cannulated 6T Tap 8.5	
1010030008	Tapping 6T Fine Thread	
1010030005	6T Tap 4.8 4T	
1010030006	6T Tap 5.5 4T	
1010030007	6T Tap 6.5 4T 6T Tap 7.2 4T	
1010030019	Cannulated Tapping 6T Fine Thread	optional
1010030016	Cannulated 6T Tap 4.8 4T	
1010030017	Cannulated 6T Tap 5.5 4T	
1010030018	Cannulated 6T Tap 6.5 4T	
1010030011	Cannulated 6T Tap 7.2 4T Cannulated 6T Tap 8.5 4T	



*Instruments*

Item no.	Description
055059	Monoaxial Screw Driver Ø 5.5 mm
1001011000	Polyaxial Screw Inserter <span style="float: right;">optional</span>
055061	Polyaxial Screw Driver
055065	Set Screw Inserter
1008010014	MIS Set Screw Driver
1001010065	Reposition Screw Driver
1010030009	Rescue Screw Driver

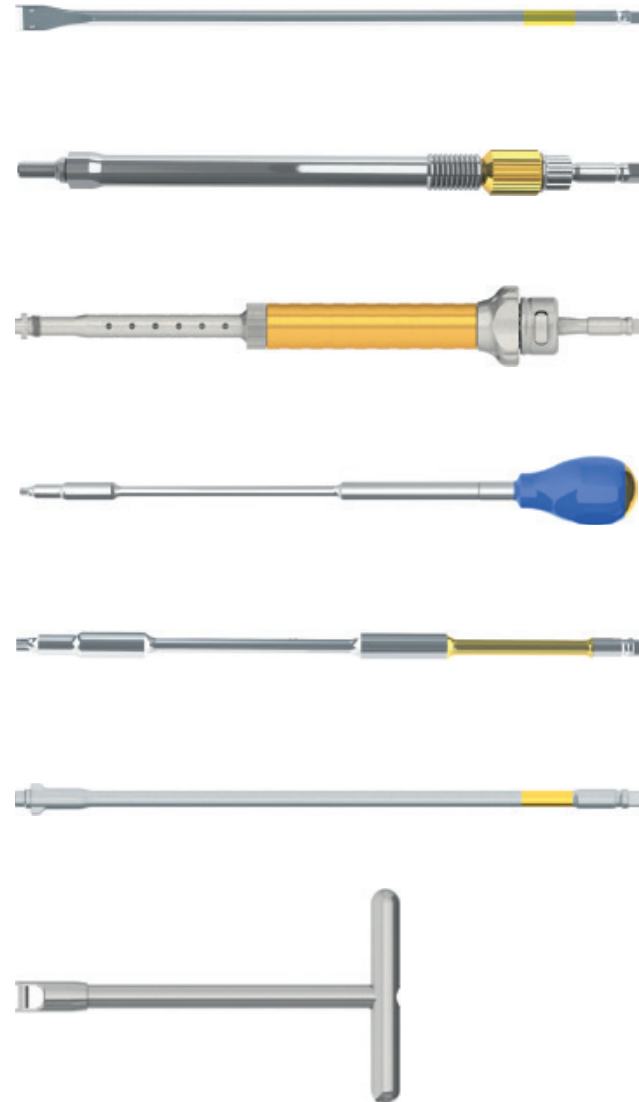

Item no.	Description
055077	T-Handle optional
1006010600	T-Handle Cannulated optional
055078	Ratchet T-Handle optional
1006010700	Ratchet T-Handle Cannulated optional
1006010701	Ratchet T-Handle Cannulated T30
055079	Handle Straight optional
1006010900	Handle Straight Cannulated optional



Item no.	Description
055080	Ratchet Handle Straight optional
1006010800	Ratchet Handle Straight Cannulated optional
1006010801	Ratchet Handle Straight Cannulated T30
1006010501	Ratchet Handle Pear Shaped Cannulated T30
1001012000	Torque Driver-12

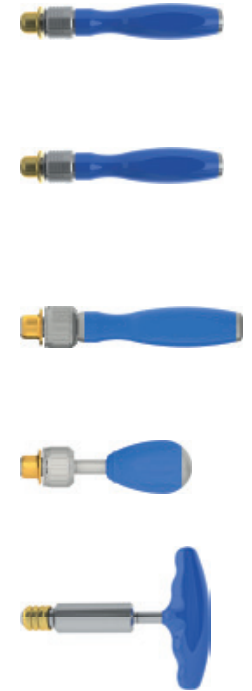

## Instruments

Item no.	Description
1007010058	Persuader Forceps Style
055071	Approximator Clamp ø 5.5mm
1016000000	Deformity-Tower
1016200000	Key Deformity Tower
1016100000	Derotation Extension DT

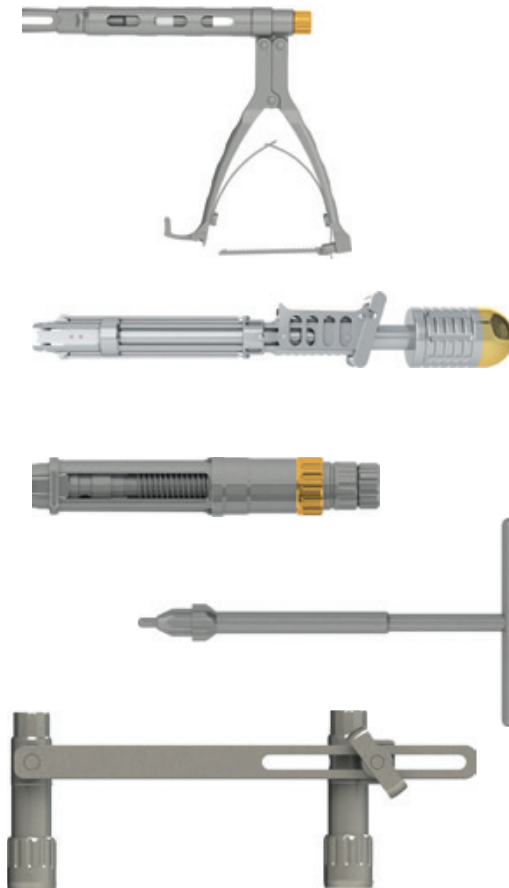



Item no.	Description
055081	Rod Pusher
055327	Depth Gauge
055083	Bending Iron Ø 5.5mm
055063	Counter Holder Ø 5.5mm
055057	Phantom Rod Nitinol 200mm
055273	Phantom Rod Nitinol 400mm
1001010048	Rocker Ø 5.5mm

optional



*Instruments*

Item no.	Description
1001010050	Transverse Connector Inserter
1001010051	Transverse Connector Rod Holder
1001010052	Rod Inserter
055259	Compressor
1001010049	Underrod Compressor optional
055262	Distractor
1001010046	Underrod Distractor optional
055293	Parallel Compressor AT optional
055294	Parallel Distractor AT optional

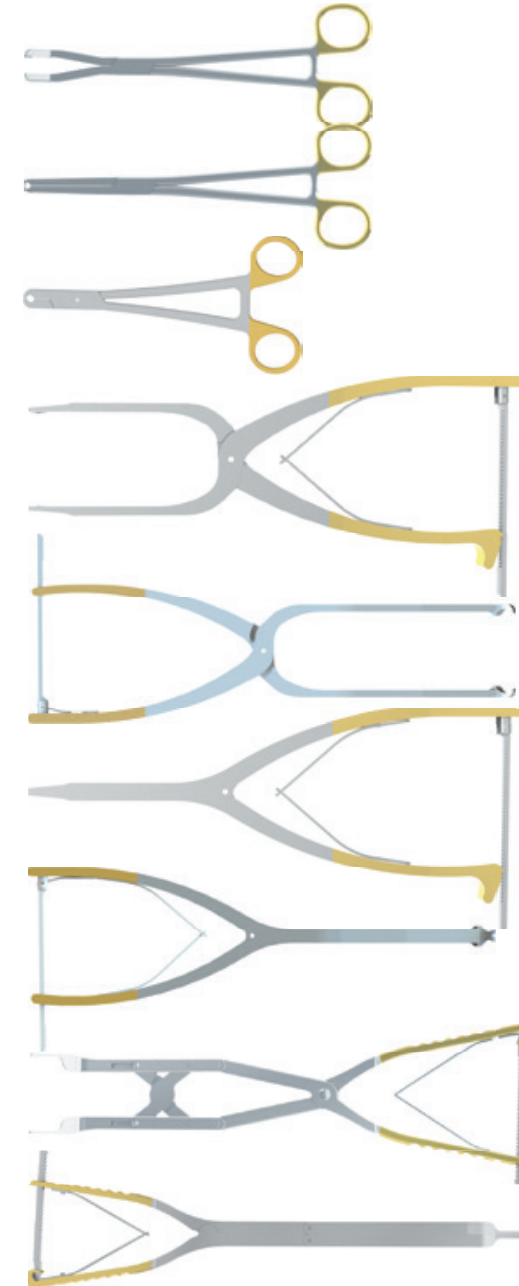

Item no.	Description
055084	Rod Cutter 5.50 & 6.35
055069	Rod Bender
055072	Rod Holder
055325	Derotation Forceps



## Iliac Screw Kit (optional)

### Optional Implants

Item no.	Description	Diameter	Length
1006117270	Polyaxial Iliac Screw Ø 7.2mm x 70mm	7.2mm	70mm
1006117280	Polyaxial Iliac Screw Ø 7.2mm x 80mm	7.2mm	80mm
1006117290	Polyaxial Iliac Screw Ø 7.2mm x 90mm	7.2mm	90mm
10061172100	Polyaxial Iliac Screw Ø 7.2mm x 100mm	7.2mm	100mm
1006118570	Polyaxial Iliac Screw Ø 8.5mm x 70mm	8.5mm	70mm
1006118580	Polyaxial Iliac Screw Ø 8.5mm x 80mm	8.5mm	80mm
1006118590	Polyaxial Iliac Screw Ø 8.5mm x 90mm	8.5mm	90mm
10061185100	Polyaxial Iliac Screw Ø 8.5mm x 100mm	8.5mm	100mm
10061185120	Polyaxial Iliac Screw Ø 8.5mm x 120mm	8.5mm	120mm

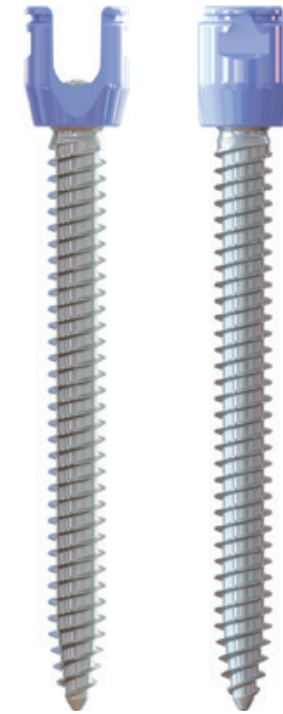

## 2T Long Headed Screws (optional)

Item no.	Description
4000034830	2T Reduction Screw Ø4.8mm x 30mm
4000034830	2T Reduction Screw Ø4.8mm x 35mm
4000034830	2T Reduction Screw Ø4.8mm x 40mm
4000034830	2T Reduction Screw Ø4.8mm x 45mm
4000034830	2T Reduction Screw Ø5.5mm x 30mm
4000034830	2T Reduction Screw Ø5.5mm x 35mm
4000034830	2T Reduction Screw Ø5.5mm x 40mm
4000034830	2T Reduction Screw Ø5.5mm x 45mm
4000034830	2T Reduction Screw Ø5.5mm x 50mm
4000034830	2T Reduction Screw Ø6.5mm x 35mm
4000034830	2T Reduction Screw Ø6.5mm x 40mm
4000034830	2T Reduction Screw Ø6.5mm x 45mm
4000034830	2T Reduction Screw Ø6.5mm x 50mm
4000034830	2T Reduction Screw Ø6.5mm x 55mm
4000034830	2T Reduction Screw Ø7.2mm x 40mm
4000034830	2T Reduction Screw Ø7.2mm x 45mm
4000034830	2T Reduction Screw Ø7.2mm x 50mm
4000034830	2T Reduction Screw Ø7.2mm x 55mm
4000034830	2T Reduction Screw Ø7.2mm x 60mm
4000034830	2T Reduction Screw Ø7.2mm x 80mm
4000034830	2T Reduction Screw Ø7.2mm x 100mm



## 6T Long Headed Screws (optional)

Item no.	Description
1005105540	Reduction Screw 6T Ø5.5 x 40mm
1005105545	Reduction Screw 6T Ø5.5 x 45mm
1005105550	Reduction Screw 6T Ø5.5 x 50mm
1005105555	Reduction Screw 6T Ø5.5 x 55mm
1005106540	Reduction Screw 6T Ø6.5 x 40mm
1005106545	Reduction Screw 6T Ø6.5 x 45mm
1005106550	Reduction Screw 6T Ø6.5 x 50mm
1005106555	Reduction Screw 6T Ø6.5 x 55mm
1005107240	Reduction Screw 6T Ø7.2 x 40mm
1005107245	Reduction Screw 6T Ø7.2 x 45mm
1005107250	Reduction Screw 6T Ø7.2 x 50mm
1005107255	Reduction Screw 6T Ø7.2 x 55mm



## Long Headed Screws - Reduction Kit (optional) *Optional Instruments*

Item no.	Name
1005010041	Long Head Sleeve
1005010039	Shaft Reduction Screw Driver
1005010040	Reduction Crown Breaker

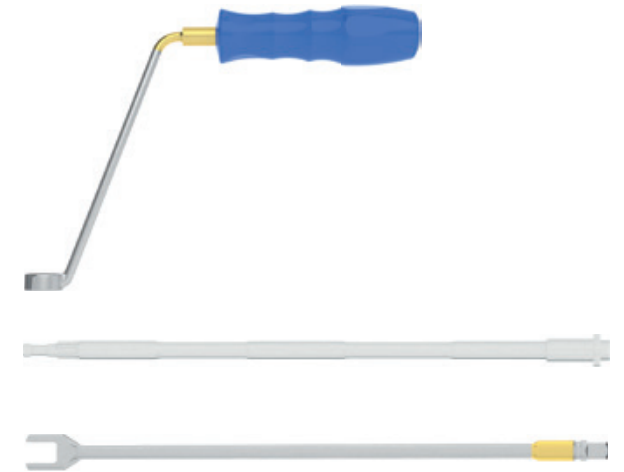

## Hook Kit (optional)

Item no.	Description	Width	Length
1004040109	Lamina Hook	5.8mm	9mm
1004040108	Lamina Hook	5.8mm	8mm
1004040107	Lamina Hook	5.8mm	7mm
1004040108R	Right Angled Lamina Hook	5.8mm	8mm
1004040108L	Left Angled Lamina Hook	5.8mm	8mm
1004050009	Pedicle Hook	10.5mm	9mm
1004050008	Pedicle Hook	10.5mm	8mm
1004050007	Pedicle Hook	10.5mm	7mm
1004060000L	Offset Hook Left	6.0mm	17mm
1004060000R	Offset Hook Right	6.0mm	17mm



Item no.	Description
1004010033	Lamina Finder
1004010034	Supra Lamina Finder
1004010035	Pedicle Finder
1004010036	Hook Impactor
1004010038	Hook Holder curved



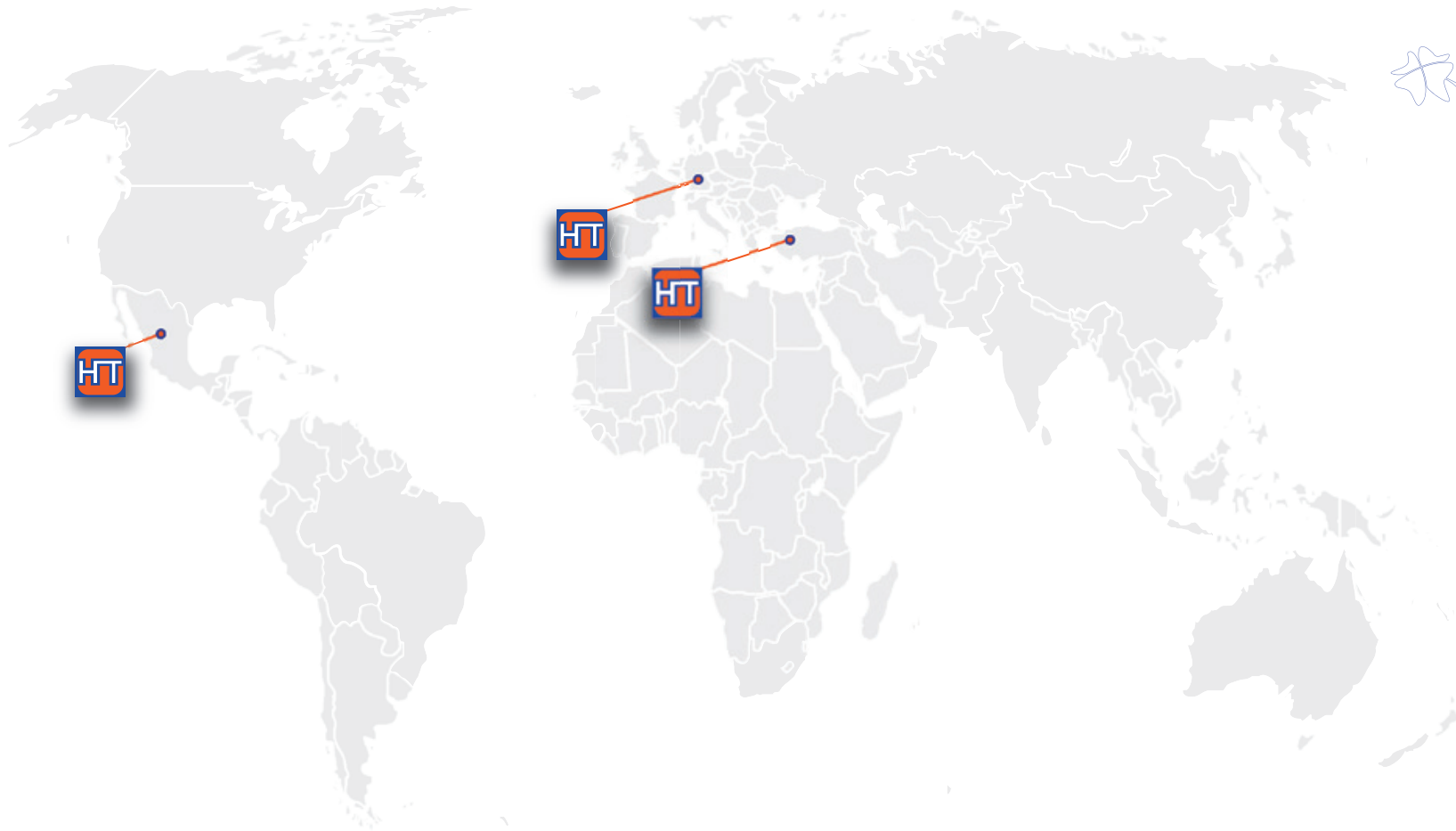

### Manufacturer and Marketing Europe

HumanTech Germany GmbH

Gewerbestr. 5  
D-71144 Steinenbronn

Germany

Phone: +49 (0) 7157/5246-71  
Fax: +49 (0) 7157/5246-66  
sales@humantech-solutions.de  
www.humantech-solutions.de

### Marketing Middle East

HumanTech Med. Sag. Tic. Ltd.

İkitelli OSB Tümsan 2. Kısım  
C-Blok No: 47  
TR-34306 Başakşehir İstanbul

Turkey

Phone: +90 (0) 212/485 6675  
Fax: +90 (0) 212/485 6674  
info@humantech.com.tr  
www.humantech-solutions.de

### Marketing Latin America

HumanTech Mexico, S. DE R.L. DE C.V.

Rio Mixcoac No. 212-3  
Acacias del Valle  
Del. Benito Juárez  
C.P. 03240 Mexico, D.F.  
Mexico

Phone: +52 (0) 55/5534 5645  
Fax: +52 (0) 55/5534 4929  
info@humantech-solutions.mx  
www.humantech-solutions.de

### Other countries

HumanTech Germany GmbH

Gewerbestr. 5  
D-71144 Steinenbronn

Germany

Phone: +49 (0) 7157/5246-71  
Fax: +49 (0) 7157/5246-66  
sales@humantech-solutions.de  
www.humantech-solutions.de

